



FARADAY COPPER

Developing U.S. Copper Resources

CORPORATE PRESENTATION
September 2023

CAUTIONARY STATEMENT



Some of the statements in this presentation, other than statements of historical fact, are “forward-looking statements” and are based on the opinions and estimates of management as of the date such statements are made and are necessarily based on estimates and assumptions that are inherently subject to known and unknown risks, uncertainties and other factors that may cause actual results, level of activity, performance or achievements of Faraday Copper Corp. (“Faraday Copper” or “Faraday” or “The Company”) to be materially different from those expressed or implied by such forward-looking statements. Forward-looking statements and information may be identified by such terms as “anticipates”, “believes”, “targets”, “estimates”, “plans”, “expects”, “may”, “will”, “could” or “would”. Although Faraday Copper believes the expectations expressed in such forward-looking statements are based on reasonable assumptions, such statements should not be in any way construed as guarantees of future performance and actual results or developments may differ materially. Accordingly, readers should not place undue reliance on forward-looking statements or information. The Company does not undertake to update any forward-looking statements or information except as may be required by applicable securities laws.

Factors that could cause actual results to differ materially from those in forward-looking statements include without limitation: market prices for metals; the conclusions of detailed feasibility and technical analyses; lower than expected grades and quantities of resources; receipt of regulatory approval; mining rates and recovery rates; significant capital requirements; price volatility in the spot and forward markets for commodities; fluctuations in rates of exchange; taxation; controls, regulations and political or economic developments in the countries in which Faraday does or may carry on business; the speculative nature of mineral exploration and development, competition; loss of key employees; rising costs of labour, supplies, fuel and equipment; actual results of current exploration or reclamation activities; accidents; labour disputes; defective title to mineral claims or property or contests over claims to mineral properties; unexpected delays and costs inherent to consulting and accommodating rights of Indigenous peoples and other groups; risks, uncertainties and unanticipated delays associated with obtaining and maintaining necessary licenses, permits and authorizations and complying with permitting requirements, including those associated with the Copper Creek property; and uncertainties with respect to any future acquisitions by Faraday. In addition, there are risks and hazards associated with the business of mineral exploration, development and mining, including environmental events and hazards, industrial accidents, unusual or unexpected formations, pressures, cave-ins, flooding and the risk of inadequate insurance or inability to obtain insurance to cover these risks as well as “Risk Factors” included in Faraday’s disclosure documents filed on and available at www.sedarplus.ca.

The metrics presented in this presentation are based on a PEA that includes an economic analysis of the potential viability of Mineral Resources. Mineral Resources that are not Mineral Reserves do not have demonstrated economic viability. This PEA is preliminary in nature, includes Inferred Mineral Resources that are considered too speculative geologically to have the economic considerations applied to them that would enable them to be categorized as Mineral Reserves, and there is no certainty the PEA will be realized.

This presentation makes reference to certain non-IFRS measures including production cash costs and all-in sustaining costs (“AISC”). These measures are not recognized under IFRS, do not have a standardized meaning prescribed by IFRS and therefore may not be comparable to similar measures presented by other issuers; however, Faraday believes that these measures are useful to assist readers in evaluating the total costs of producing copper from their operations. While there is no standardized meaning across the industry for this measure, the Company defines production cash costs as based on the direct operating costs, including mining, processing, and G&A, offsite charges, net of by-product credits. By-product credits are calculated using commodity prices: \$13.00 per pound of molybdenum and \$20.00 per ounce of silver. AISC is the sum of the production cash costs, sustaining capital expenditures and royalties.

This presentation does not constitute an offer to sell or a solicitation of an offer to buy any securities in any jurisdiction to any person to whom it is unlawful to make such an offer or solicitation in such jurisdiction. This presentation is not, and under no circumstances is to be construed as, a prospectus, an offering memorandum, an advertisement or a public offering of securities in Faraday Copper in Canada, the United States or any other jurisdiction. No securities commission or similar authority in Canada or in the United States has reviewed or in any way passed upon this presentation, and any representation to the contrary is an offence.

All of the forward-looking statements contained in this presentation are qualified by these cautionary statements. Faraday Copper does not intend, and does not assume any obligation, to update these forward-looking statements, except as required under applicable securities legislation. For more information on Faraday Copper, readers should refer to www.sedarplus.ca for the Faraday Copper’s filings with the Canadian securities regulatory authorities.

Technical information in this presentation has been reviewed and approved by Thomas Bissig, Professional Geologist, VP Exploration of the Company and Zach Allwright, Professional Engineer, VP Projects and Evaluations of the Company, both a “Qualified Person” as defined under National Instrument 43-101 - Standards of Disclosure for Mineral Projects (“NI 43-101”). Both have verified the data contained herein (where possible) which included a review of the sampling analytical and test methods underlying the data, information and opinions disclosed herein.

All amounts are in U.S. dollars unless otherwise stated.

FARADAY COPPER: HIGHLIGHTS

Building a Premier North American Copper Company



ASSET

- **Copper Creek in Arizona** is a large undeveloped project with **over 4.2 Blbs of copper M&I Mineral Resources^a** in a Tier-One jurisdiction^b
- **Delivered a robust PEA** with NPV_(7%) of \$713 M and IRR of 16%, demonstrating economic viability
- **Scarcity of development-ready copper assets** provides excellent opportunity for the project

STRATEGY

- **Growing the resource** through definition of high-grade zones and step-out drilling
- **Targeting new discoveries** in an underexplored district
- **Value engineering** aimed at higher production rates and processing optimization
- **Gold program** targeting potential gold inclusion in future resource updates

CATALYSTS

- **20,000 m Phase III drill program** commencing (Q4 2023)
- **Gold Program** results (H2 2023 – H1 2024)
- **Technical Report** update (H1 2025)

Notes:

a) The Mineral Resource Estimate ("MRE") for the Copper Creek project was published in a news release dated May 3, 2023. For the complete MRE tables and related notes refer to the relevant slides at the end of this presentation.

b) Tier-One mining jurisdiction is defined as one of the top 10 jurisdictions in the Investment Attractiveness Index of the Fraser Institute Annual Survey of Mining Companies, 2022.

FARADAY COPPER: COMPELLING INVESTMENT



Low Capital Intensity, Long Life U.S. Copper Project Owned by a Developer

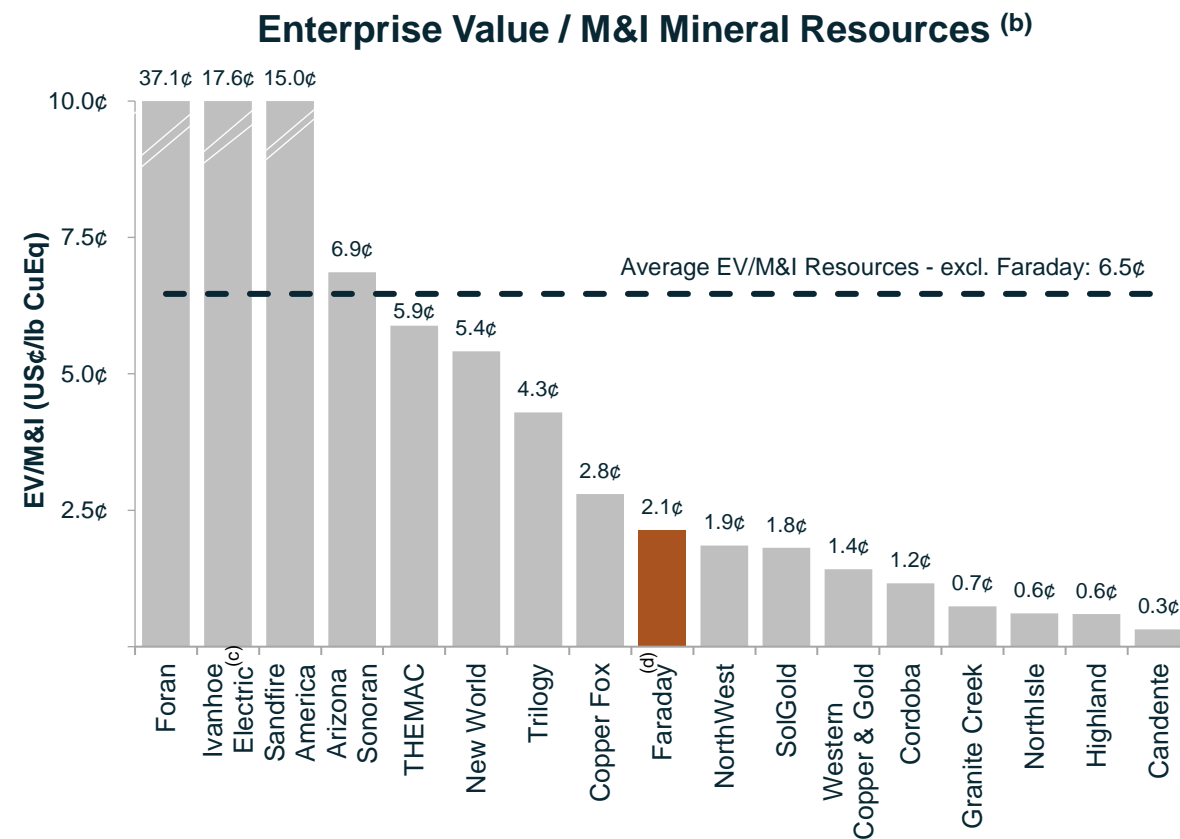
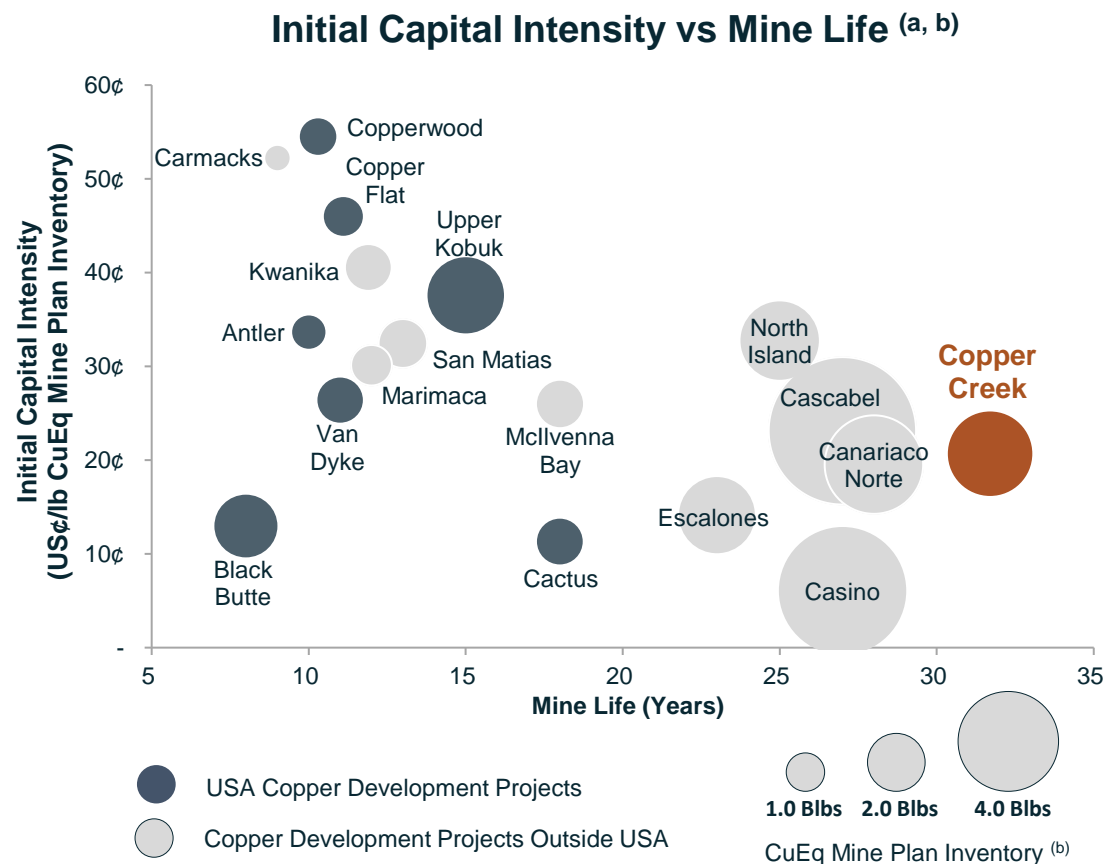

Source: Company disclosure, S&P Capital IQ and S&P Capital IQ Pro as at May 2, 2023.

a) Includes copper projects with recent technical studies (preliminary economic assessment, prefeasibility study, and definitive feasibility study). Located in the Americas and owned by non-producing companies.

b) CuEq mine plan inventory includes Measured, Indicated and Inferred Mineral Resources contemplated as mine plan inventory within a technical report as described in Footnote (1), and is based on applicable prices utilized in the Copper Creek PEA of \$3.80/lb Cu, \$20.00/oz Ag, and \$13.00/lb Mo, and consensus long-term commodity prices of \$1,675/oz Au, \$0.95/lb Pb and \$1.25/lb Zn.

c) Ivanhoe Electric has not issued a technical study as of the date of this presentation.

d) Faraday Copper's figure excludes the Contact Copper project as the Mineral Resource is deemed to be historical.

CORPORATE OVERVIEW

TSX-listed Under the Symbol “FDY”



Analyst Coverage



Dalton Baretto



Roger Bell



Connor Mackay



Alex Terentiew



Arun Lamba

Financial Overview

C\$125.0 M Market Capitalization

C\$40.0 M Recent Financing (Feb 14, 2023)

C\$22.3 M Cash & Equivalents (June 30, 2023)

176.0 M Shares Outstanding

12.2 M Options

12.5 M Warrants

2.8 M Restricted Share Units

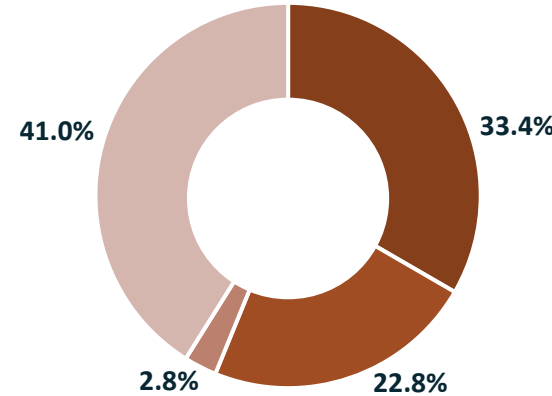

Ownership

- Strategic Shareholders: 33.4%
- Institutions: 22.8%
- Insiders: 2.8%
- Other / Retail: 41.0%

Top Strategic Shareholders

Lundin Family | Murray Edwards | Pierre Lassonde

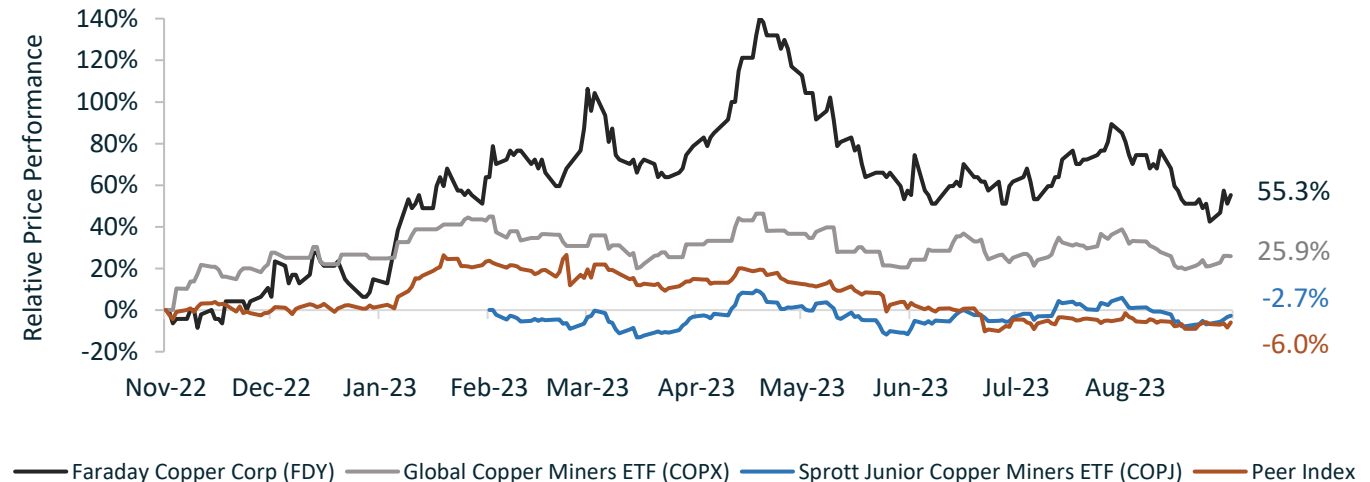

Notes: Market Capitalization as of September 5, 2023. Shares Outstanding, Options, Warrants, and Restricted Share Units as of June 30, 2023. Ownership as of February 14, 2023. Each warrant entitles the holder to purchase one common share at an exercise price of \$0.60 at any time up to September 2026. Peer Index includes the peer group in the slide titled “Faraday Copper: Compelling Investment” within the Enterprise Value chart.

COPPER CREEK: TOP MINING JURISDICTION



Arizona Ranked Seventh for Investment Attractiveness (Fraser Institute, 2022)

- 100% owned property in Pinal County, Arizona
- Near mining and service hubs with skilled labour:
 - ~80 road km northeast of Tucson
 - ~25 road km northeast of San Manuel
- Excellent infrastructure with access to road, rail and power
- Two smelters in the region:
Hayden (Ray) & Miami (Freeport)

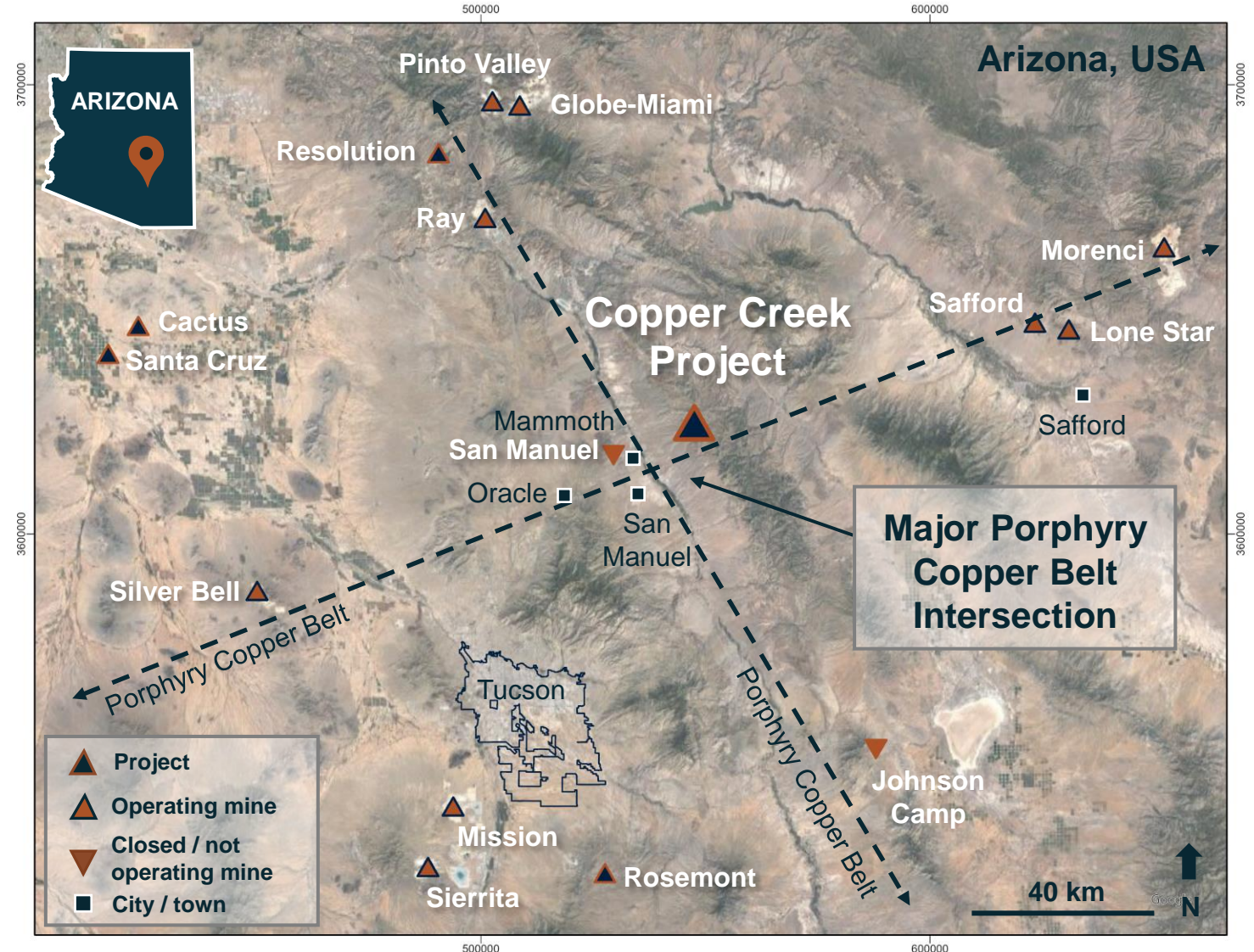

COPPER CREEK: LARGE LAND PACKAGE

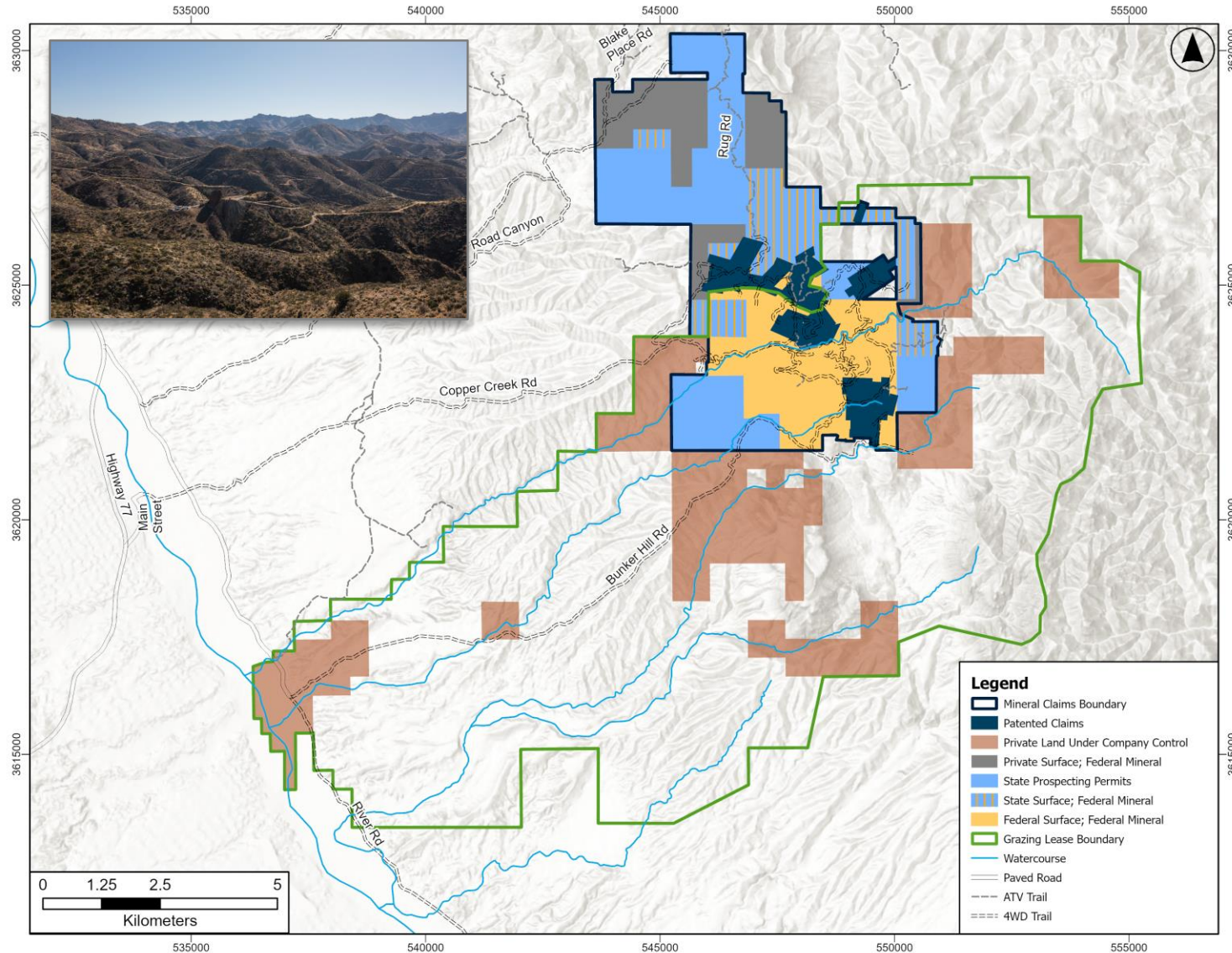

- ~65 km² Property offers strategic benefits
- Mineral claims include patented claims, unpatented claims and state prospecting permits
- Optionality for infrastructure placement
- Solar power generation potential
- Ranch includes ~26,000 acres of surface rights through active grazing leases

UPDATED MINERAL RESOURCE (2023)



MRE is Supported by >200,000 m of Drilling, 83% of Resource is M&I

- Drillhole database includes Phase I drill results (as of Oct 27, 2022)
- Updated geological model
- Assay results from over 1,600 m of unsampled historical core
- Additional specific gravity test work
- Updated high-resolution topographical surveys
- Updated open pit and underground resource constraints for RPEEE, which includes variable cut-off grade based on material type
- Underground grade is fully diluted

Category	Tonnes (Mt)	Cu (%)	Mo (%)	Ag (g/t)	CuEq ² (%)	Cu (Mlbs)	Mo (Mlbs)	Ag (Moz)	CuEq ² (Mlbs)
Open Pit NI 43-101 MRE									
M&I	127.1	0.40	0.008	0.9	0.43	1,123.4	22.6	3.8	1,191.6
Inferred	48.1	0.28	0.006	0.5	0.30	298.4	6.4	0.7	316.0
Underground NI 43-101 MRE									
M&I	294.8	0.47	0.008	1.2	0.50	3,080.4	52.0	11.8	3,264.8
Inferred	35.5	0.42	0.009	0.8	0.45	329.7	7.1	0.9	353.0
Combined NI 43-101 MRE									
M&I	421.9	0.45	0.008	1.1	0.48	4,203.8	74.6	15.5	4,456.4
Inferred	83.6	0.34	0.007	0.6	0.36	628.2	13.4	1.7	669.0

Notes: Totals may not add due to rounding. The MRE for the Copper Creek project was published in a news release dated May 3, 2023. For the complete MRE tables and related notes refer to the relevant slides at the end of this presentation. Pit shell constrained resources with Reasonable prospects for eventual economic extraction ("RPEEE") are stated as contained within estimation domains above cut-off grades: 0.13% CuEq for oxide material, 0.14% CuEq for transitional material, and 0.13% CuEq for sulphide material. Pit shells are based on an assumed metal prices of US\$3.80/lb copper, US\$13.00/lb molybdenum, US\$20.00/oz silver, and overall slope angle of 47 degrees (°) based on preliminary geotechnical data. Operating cost assumptions include open pit mining cost of US\$2.25/tonne (t), processing cost of US\$7.60/t for milling transitional and sulphide material, US\$4.56/t for oxide processing, general and administrative ("G&A") costs of US\$1.00/t, and TCRC and freight costs dependent on product and material type.

Underground constrained resources with RPEEE are stated as contained within estimation domains above 0.31% CuEq cut-off grade. Underground bulk mining footprints are based on assumed metal prices of \$3.80/lb copper, \$13.00/lb molybdenum, \$20.00/oz silver, and underground mining cost of US\$7.30/t, processing cost of US\$7.60/t, G&A costs of US\$1.00/t, and TCRC and Freight costs of US\$6.50/t. Cave footprint optimization was completed in Geovia's Footprint Finder software and applied a 700 m maximum height of draw.

Preliminary variable metallurgical recovery by metal and domain are considered for CuEq as follows: copper recovery of 92%, 85%, and 60% within sulphide, transitional, and oxide material, respectively; molybdenum recovery of 78% and 68% for sulphide and transitional material, respectively; and silver recovery of 50% and 40% for sulphide and transitional material, respectively.

SIGNIFICANT RESOURCE WITH UPSIDE



Open Pit and Underground Mineral Resource

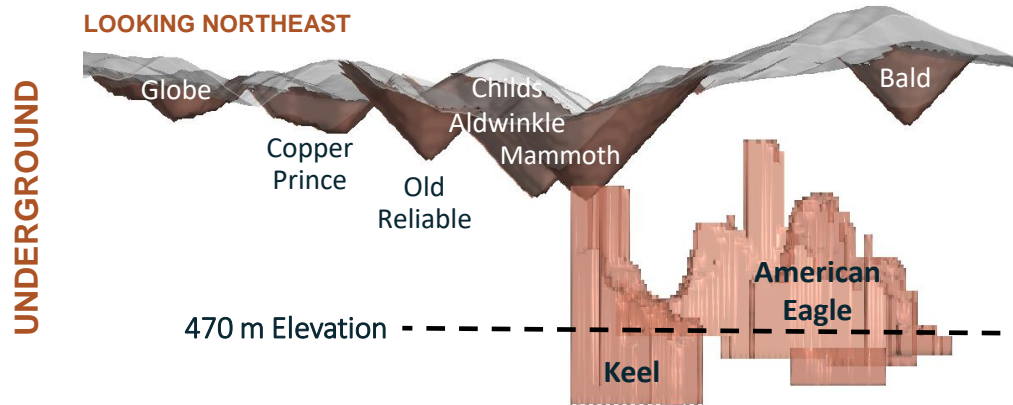
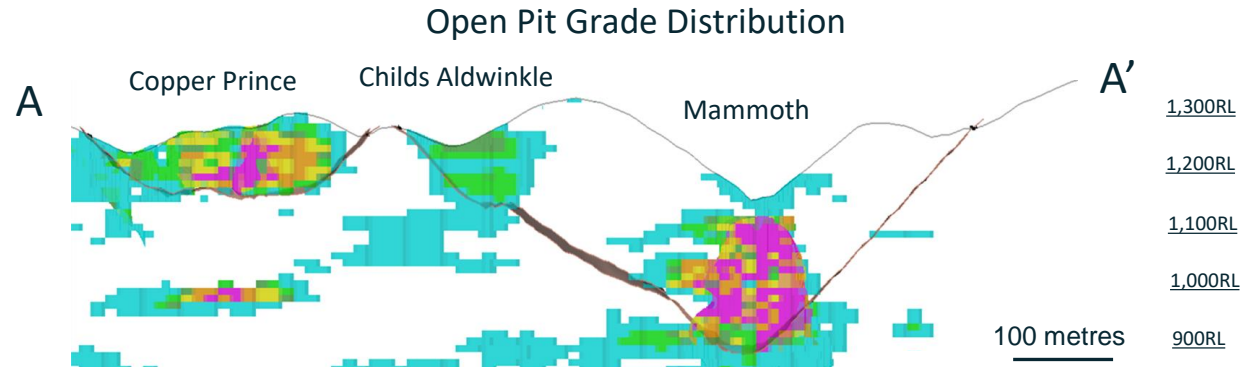
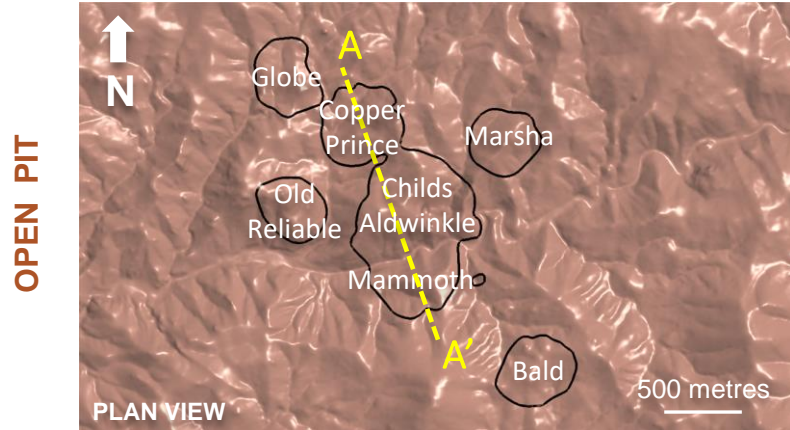

Underground Grade Distribution (plan view at 470 m Elevation)

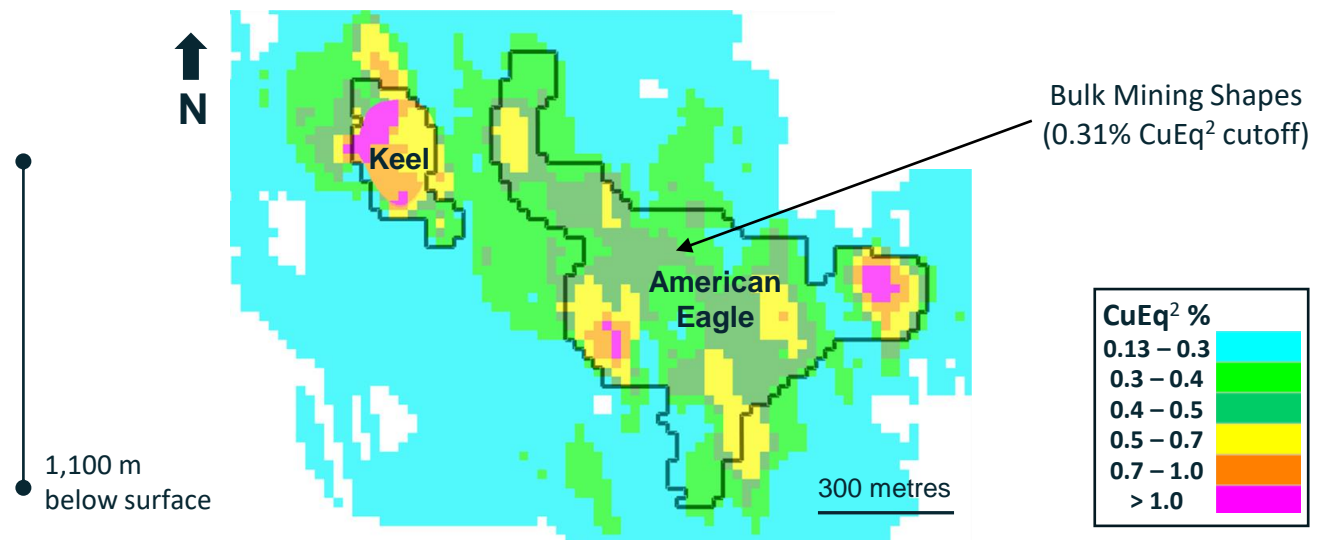

Note: The images above reflect conceptual open pit shells constrained with RPEEE at CuEq² cut-off grades of 0.13% for oxide material, 0.14% for transitional material, and 0.13% for sulphide material. Underground footprints constrained with RPEEE are stated as contained within estimation domains above 0.31% CuEq² cut-off grades. These were utilized as the resource constraining volumes in the 2023 MRE disclosed in a news release dated May 3, 2023. The potential grade and scale of the open pit and underground inventory is conceptual in nature. There has been insufficient technical analysis to define it as economically viable inventory or mineable reserve.

PEA HIGHLIGHTS



51,100 tpa

Life-of-Mine Average Annual Payable CuEq¹ Production

3.4 Blb

Life-of-Mine Payable CuEq¹ Production

4.2 Blb

Measured and Indicated Copper Mineral Resource^a

KEY FINANCIAL DATA

Post-tax NPV _(7%)	\$713 million
Post-tax IRR	15.6%
Post-tax Payback Period	4.1 years
Post-tax NPV _(7%) / Initial Capital Ratio	0.9:1
Initial Capital	\$798 million
Sustaining and Expansion Capital	\$1,689 million
Closure and Reclamation	\$170 million
Metal Prices	\$3.80/lb Cu, \$13.00/lb Mo, \$20/oz Ag

ANTICIPATED PRODUCTION PROFILE

Mine Life ^b	32 years
Tonnes Milled ^c	10.8 Mtpa / 30,000 tpd
Open Pit Strip Ratio (waste:ore)	1.2:1
Copper Recovery (sulphide)	94.4%

Payable Production (per year)^{d, e}

Copper	106 Mlbs
Molybdenum	1.4 Mlbs
Silver	324.6 Koz
CuEq ¹	51.1 Kt

Costs (by product)³

LOM Production Cash Costs	\$1.67/lb Cu
LOM All-in Sustaining Costs	\$1.85/lb Cu

Note: Refer to the Endnotes slide at the end of this presentation.

- a) The Mineral Resource Estimate was published in a news release dated May 3, 2023. For the complete MRE tables and related notes refer to the relevant slides at the end of this presentation.
- b) Mine life includes active mining (Year 1 – 29) and final processing of stockpiles (Year 30 – 32)
- c) Tonnes milled are exclusive of oxide and represent the average over the 32-year life of mine.
- d) Average annual production considers the period of active mining during Years 1 - 29, Year 30 – 32 includes processing of stockpiles only.
- e) Based on payability in concentrate of 96.5%, 95% and 98.5% for copper, silver, and molybdenum, respectively. Copper cathode payability of 98% is applied.

PEA MINE DESIGN OVERVIEW



Integrated Mine Plan Provides Optionality and Scalability

Open pit mining enables rapid payback on initial capital and funds development of bulk underground mine

Multiple concurrent mill feed sources provide higher-grade optionality and productivity

Underground production design utilizes dedicated conveyor decline with synergies to surface infrastructure

Underground development configuration allows for scalability

Practical mine designs and dynamic software-based schedule optimizations

ISOMETRIC VIEW
LOOKING NORTHEAST

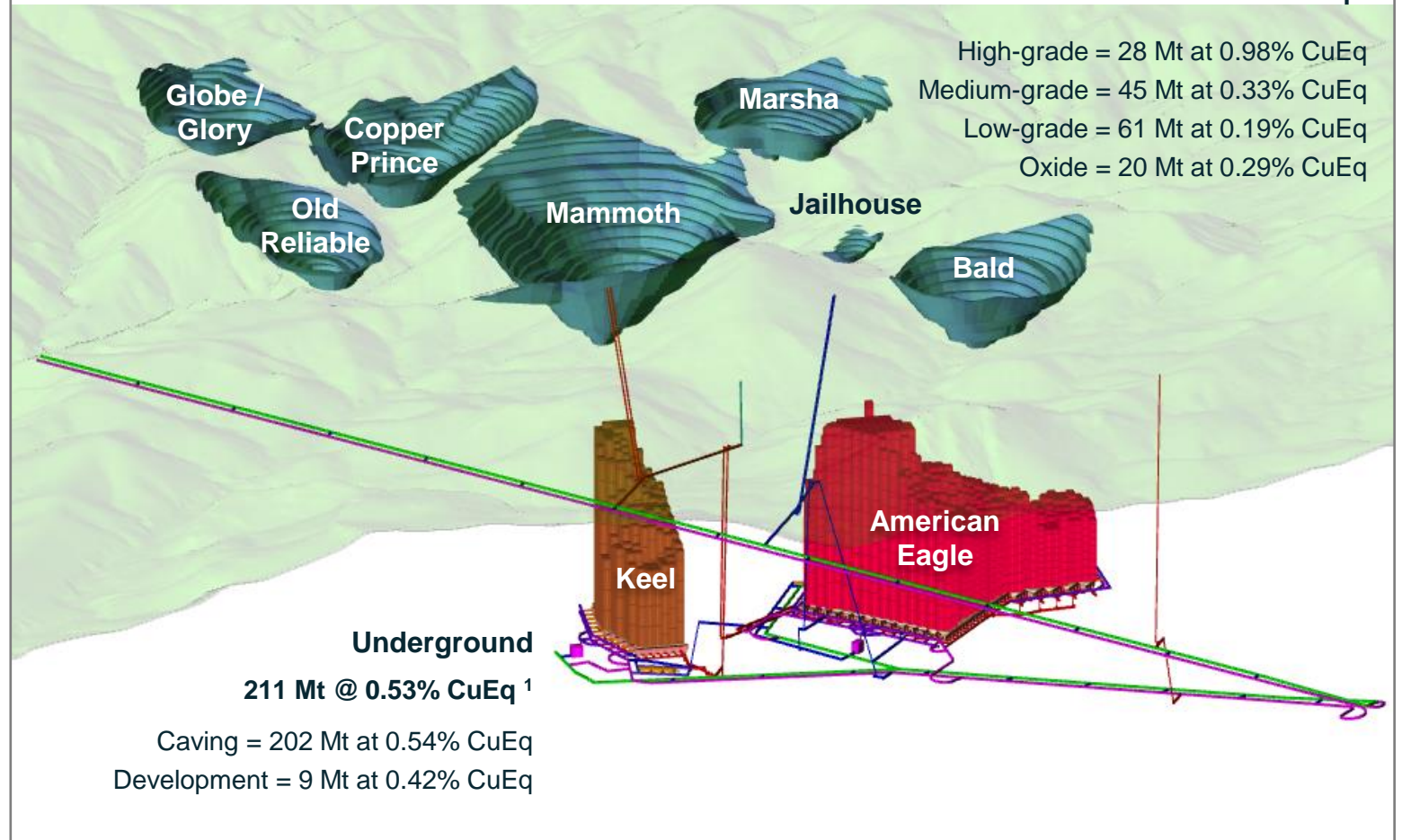

Note: Rum pit is not shown in the image above. Tonnages and grade are inclusive of Inferred material. Mammoth pit includes the Mammoth and Childs Aldwinkle breccias, and the Copper Prince pit includes numerous breccias such as the Copper Prince, Copper Giant, Copper Duchess, and Copper Knight.

RESOURCE POTENTIAL: PHASE II RESULTS (POST-PEA)



High-grade intercept below Copper Prince

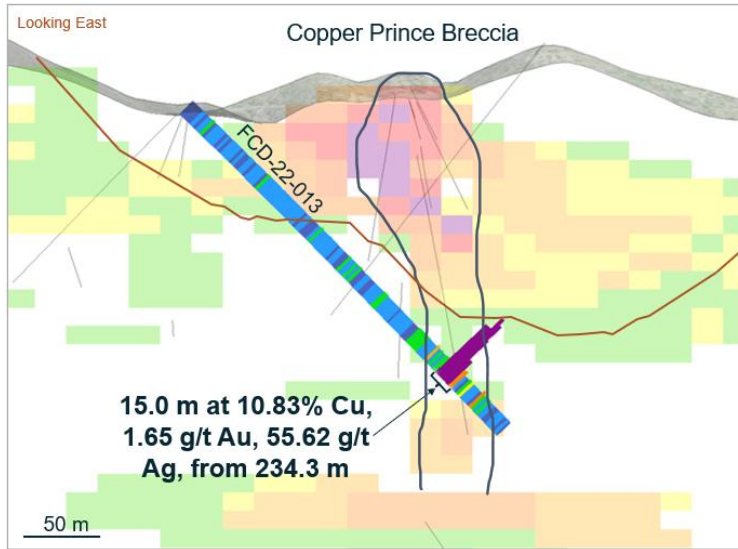

High-grade intercept below Copper Giant

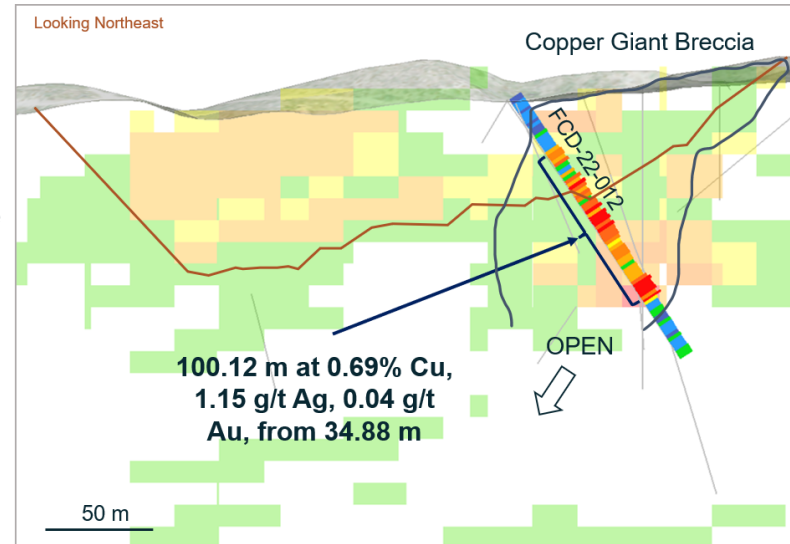

Potential for expansion above American Eagle underground

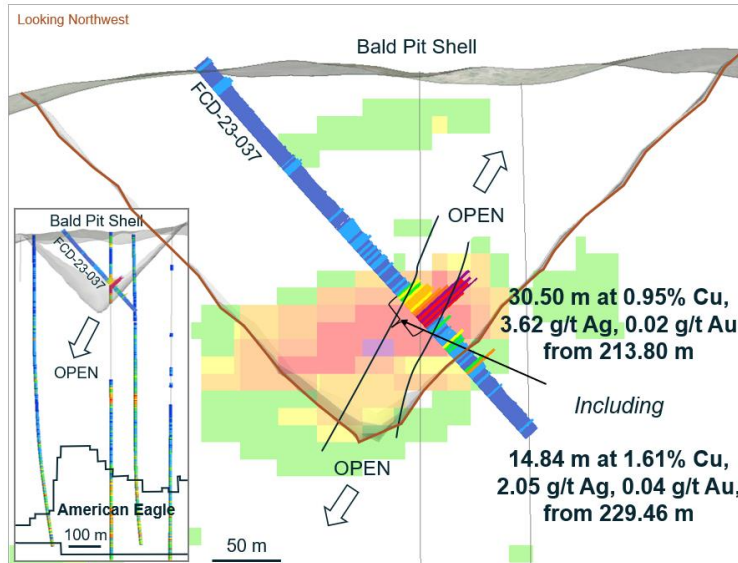

Potential for westerly extension of Keel

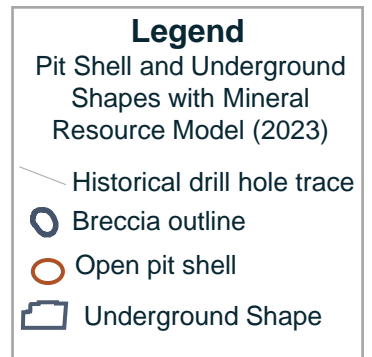
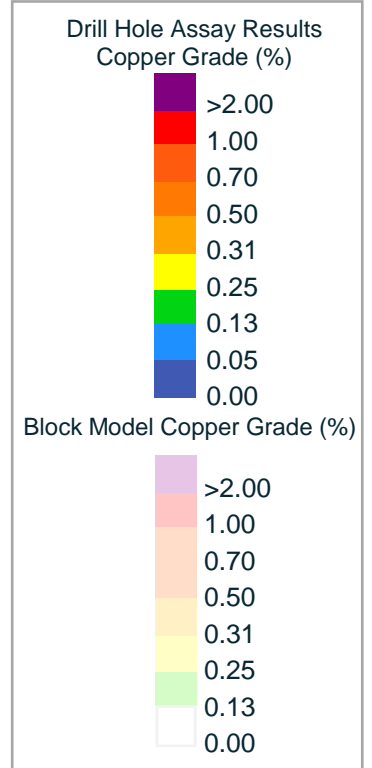
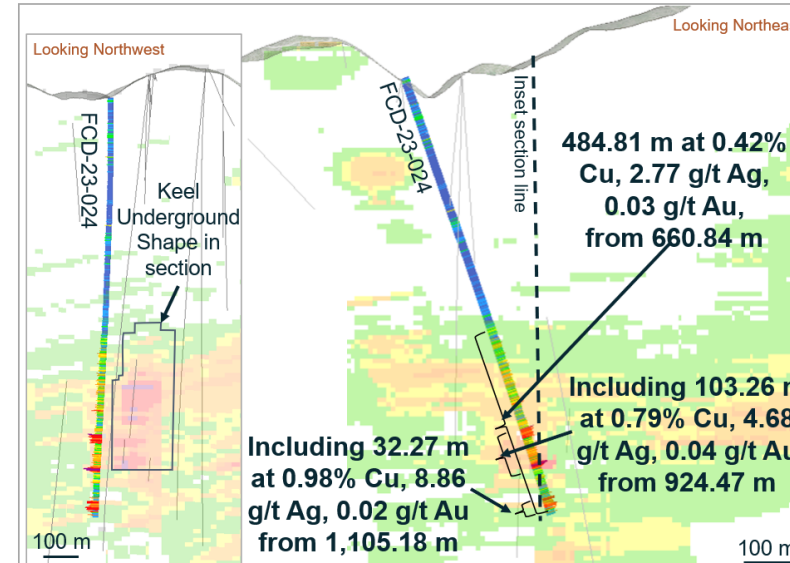

Note: For further details refer to the Company's news releases dated January 17, 2023, March 14, 2023, May 31, 2023 and August 1, 2023.

RESOURCE EXPANSION POTENTIAL

Significant Growth Opportunities

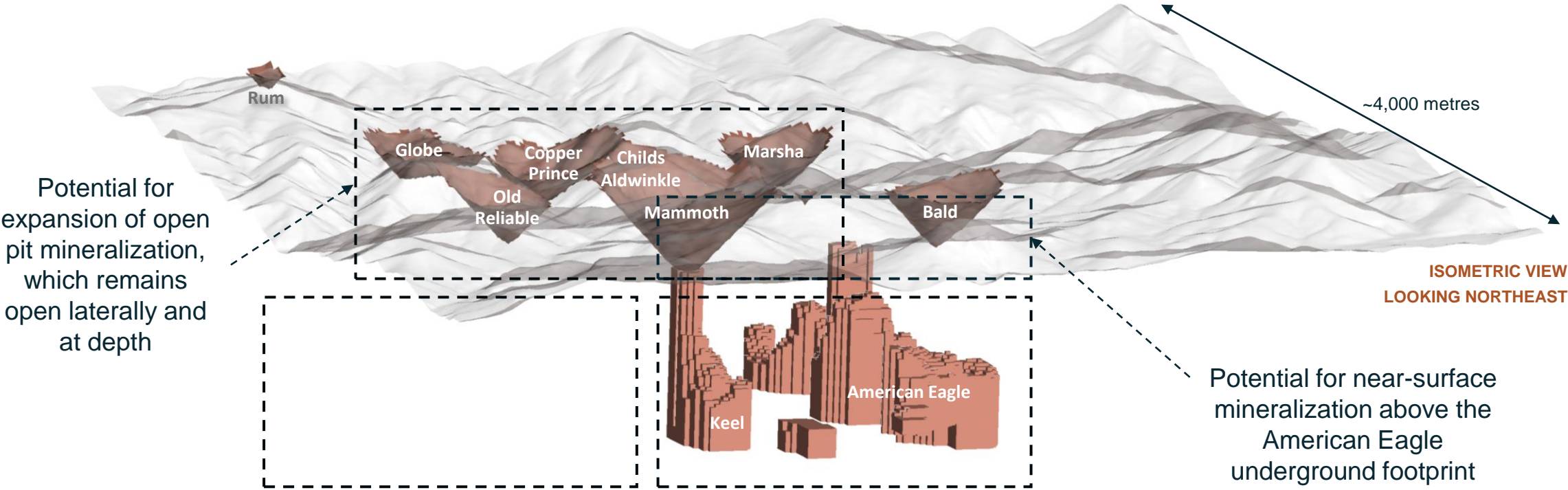

Potential for underground porphyry feeder system

Potential to delineate further high-grade centers with angled drill holes

2023 Mineral Resource Constraining Shapes

- Open Pit Shells
- Underground Footprint
- Topography

TARGETING NEW DISCOVERIES



Significant Growth Opportunities in an Underexplored District

- Integration of new data is driving target generation and prioritization: airborne geophysics, hyperspectral data, and new field mapping
- Multiple untested breccia and porphyry targets across the property



Massive / semi-massive supergene chalcocite from Area 51 Target

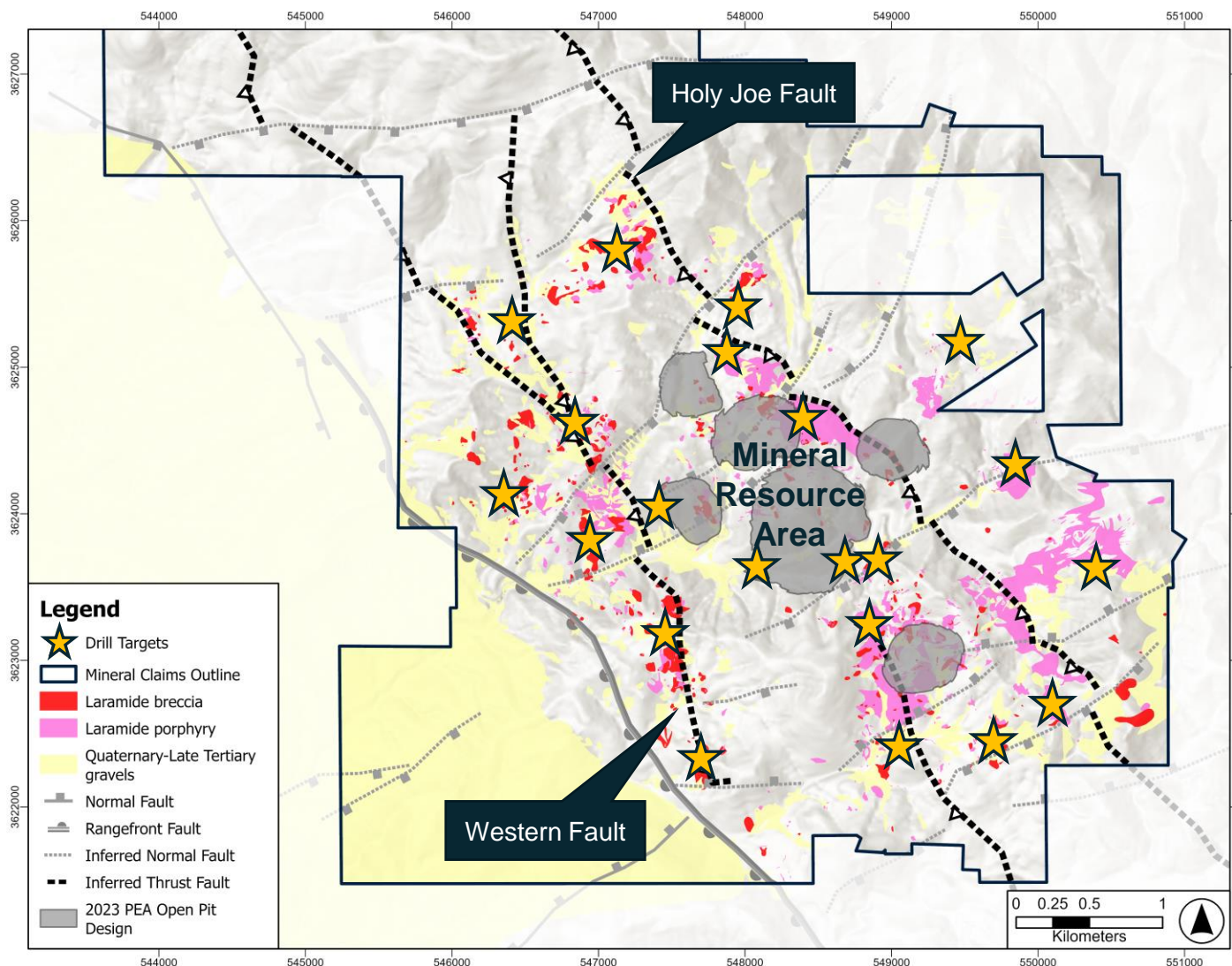

ENVIRONMENTAL & STAKEHOLDER ENGAGEMENT

Building a Framework for Data Collection and Engagement



ENVIRONMENT

Baseline environmental monitoring systems in place for data collection to support permitting process

- Flow meters and piezometer installation
- Water sampling and water elevation measurements
- Meteorological station
- Classification of waterways (404 Permit)
- Flora & fauna and archaeological & cultural studies



STAKEHOLDER ENGAGEMENT

Commitment to open dialogue and support for the local economy and social programs

- Stakeholder engagement and outreach
- Community meetings held with San Manuel, Mammoth and Oracle
- Letters, meetings, site visits and outreach to Arizona's Native American Groups
- Proactive engagement with regulators including BLM, Arizona Fish & Game, ACOE and ADEQ

OPPORTUNITIES AND NEXT STEPS



Phase II drill program

- Recent results demonstrate potential for resource expansion
- Not included in PEA

Gold by-product potential

- Targeting potential gold inclusion in future resource updates

Asset scalability

- Potential for production rate increase
- Metallurgical program targeting coarser grind and tailings optimization

Phase III drill program

- 20,000 m drill program
- Testing new targets
- Resource expansion
- Define and expand high-grade zones

District exploration

- New airborne geophysical and spectral surveys
- Field mapping and sampling
- Building a pipeline of exploration targets

2023 PEA:

~30,000 tpd mill feed
~51 ktpa CuEq production

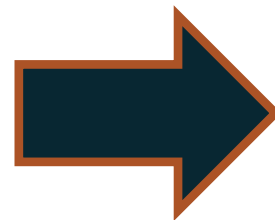

Technical Study Update (H1 2025)

Targeting:

~45,000 tpd mill feed
~75 ktpa CuEq production



FARADAY COPPER

Developing U.S. copper resources

- Scarcity of development-ready copper projects
- Large undeveloped Mineral Resource
- Significant exploration upside

CONTACT INFORMATION

Suite 250, 200 Burrard Street
Vancouver, BC Canada
www.faradaycopper.com

STACEY PAVLOVA, CFA

VP Investor Relations
778-730-1067
info@faradaycopper.com



FARADAY COPPER

APPENDIX



COPPER CREEK: MINERAL RESOURCES (2023)



Category	Tonnes (Mt)	Grade				Contained Metal			
		Cu (%)	Mo (%)	Ag (g/t)	CuEq ² (%)	Cu (Mlbs)	Mo (Mlbs)	Ag (Moz)	CuEq ² (Mlbs)
<u>Open Pit (OP)</u>									
Measured	67.2	0.48	0.008	1.2	0.51	710.5	12.5	2.6	751.1
Indicated	59.9	0.31	0.008	0.6	0.33	412.9	10.1	1.1	440.5
M&I	127.1	0.40	0.008	0.9	0.43	1,123.4	22.6	3.8	1,191.6
Inferred	48.1	0.28	0.006	0.5	0.30	298.4	6.4	0.7	316.0
<u>Underground (UG)</u>									
Measured	34.5	0.47	0.011	1.6	0.51	2,720.6	43.9	10.0	2,876.8
Indicated	260.3	0.47	0.008	1.2	0.50	3,080.4	52.0	11.8	3,264.8
M&I	294.8	0.47	0.008	1.2	0.50	329.7	7.1	0.9	353.0
Inferred	35.5	0.42	0.009	0.8	0.45				
<u>Total (OP + UG)</u>									
Measured	101.6	0.48	0.009	1.3	0.51	1,070.3	20.5	4.4	1,139.1
Indicated	320.2	0.44	0.008	1.1	0.47	3,133.5	54.0	11.2	3,317.3
M&I	421.9	0.45	0.008	1.1	0.48	4,203.8	74.6	15.5	4,456.4
Inferred	83.6	0.34	0.007	0.6	0.36	628.2	13.4	1.7	669.0

Notes: Totals may not add due to rounding. The MRE for the Copper Creek project was published in a news release dated May 3, 2023. For the related notes refer to the relevant slide in the Appendix.

COPPER CREEK: NOTES TO MINERAL RESOURCES



- CuEq: Copper equivalent; g/t: Grams per tonne; Mlb: Million pounds; Moz: Million troy ounces; Mt: Million tonnes
- The mineral resources in this estimate were prepared in accordance with the Canadian Institute of Mining, Metallurgy and Petroleum (CIM) Standards on Mineral Resources and Reserves, Definitions and Guidelines (CIM, 2014) prepared by the CIM Standing Committee on Reserve Definitions and adopted by CIM Council.
- Pit shell constrained resources with RPEEE are stated as contained within estimation domains defined by the following cut-off grades: 0.13% CuEq for oxide material, 0.14% CuEq for transitional material, and 0.13% CuEq for sulphide material. Pit shells are based on an assumed copper price of \$3.80/lb, assumed molybdenum price of \$13.00/lb, assumed silver price of \$20.00/troy ounce (oz), and overall slope angle of 47 degrees based on preliminary geotechnical data. Operating cost assumptions include open pit mining cost of \$2.25/t, processing cost of \$7.60/t for milling transitional and sulphide material, \$4.56/t for oxide processing, general and administrative (“G&A”) costs of \$1.00/t, and treatment charges and refining charges (“TCRC”) and freight costs dependent on product and material type.
- Underground constrained resources with RPEEE are stated as contained within estimation domains above 0.31% CuEq cut-off grade . Underground bulk mining footprints are based on an assumed copper price of \$3.80/lb, assumed molybdenum price of \$13.00/lb, assumed silver price of \$20.00/oz, underground mining cost of \$7.30/t, processing cost of \$7.60/t, G&A costs of \$1.00/t, and TCRC and freight costs of \$6.50/t. Cave footprint optimization was completed in Geovia's Footprint Finder software and applied a 700 m maximum height of draw.
- Average bulk density assigned by domain is as follows: 2.47 grams per cubic centimetre (g/cm³) for all near-surface breccias, 2.60 g/cm³ for the deeper Mammoth and Keel breccias, porphyry mineralisation, and all other areas outside of breccias.
- Preliminary variable metallurgical recovery by metal and domain are considered for CuEq as follows: copper recovery of 92%, 85%, and 60% within sulphide, transitional, and oxide material, respectively; molybdenum recovery of 78% and 68% for sulphide and transitional material, respectively; and silver recovery of 50% and 40% for sulphide and transitional material, respectively.
- Mineral Resource (MRE) copper equivalent (CuEq) values are calculated using commodity type and price, considering the relevant preliminary recovery rate based on domain. For example, sulphide CuEq = $[(\text{Cu grade}/100 * 0.92 \text{ Cu recovery} * 2,204.62 * \$3.80) + (\text{Mo grade}/100 * 0.78 \text{ Mo recovery} * 2,204.62 * \$13.00) + (\text{Ag grade} * 0.50 \text{ Ag recovery} * \$20.00/31.10348)] / (0.92 \text{ Cu recovery} * 2,204.62 * \$3.80) * 100$.
- Preliminary Economic Assessment (PEA) copper equivalent (CuEq) values are calculated using commodity type and price, considering the relevant recovery rate based on domain, applied using a regression formula as a function of grade. Recovery regression formulas are based on the outcomes of the 2023 metallurgical test work and associated recovery guidance. Metal prices used in the calculation include \$3.80/lb copper, \$13.00/lb molybdenum, \$20.00/oz silver.
- Mineral resources are not mineral reserves and do not have demonstrated economic viability. There is no certainty that all or any part of the mineral resources will be converted into mineral reserves in the future. The estimate of mineral resources may be materially affected by environmental permitting, legal, title, taxation, socio-political, marketing, or other relevant issues.
- All quantities are rounded to the appropriate number of significant figures; consequently, sums may not add up due to rounding.

PEA: GEOTECHNICAL ASSESSMENT

Data Collected for Open Pit and Underground Mine Design



- Geotechnical core logging
- Geomechanical data
- Fracture orientation
- Rock mass classification
- Geologic structure domaining
- Rock strength
- Laboratory test work
- Vibrating Wire Piezometer

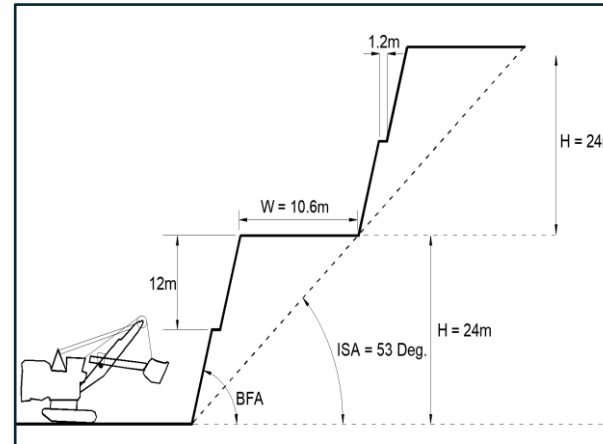

Pit slope stability assessment confirmed

- Competent host rock with reliable slope stability and reduced strip
- Overall pit slope angle of 50 degrees, supporting a low strip ratio
- 24-metre double bench height, or 12-metre single bench height

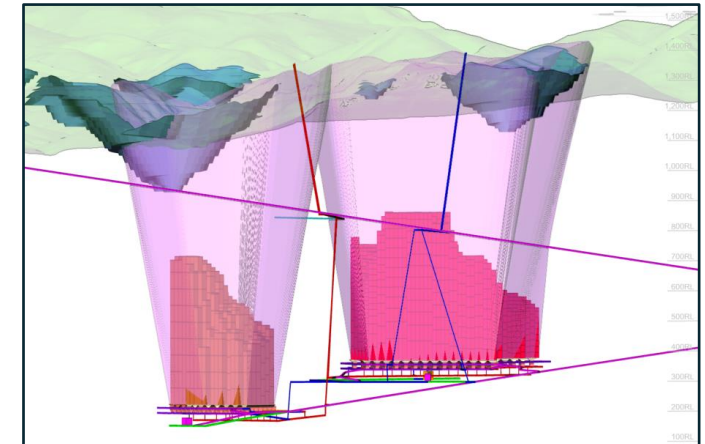

Underground caveability assessment confirmed

- Rock mass indicates a potential production range of 30 ktpd to 45 ktpd, implying there is a production rate upside beyond the PEA
- A caving rate of 55 m/year is expected
- Preconditioning is not expected to be required.

METALLURGICAL SUMMARY

High Metal Recoveries and Clean Concentrate



2023 Test work was assimilated with the historical test work to form the basis of the process design criteria for the PEA

- High copper recovery from sulphide materials
- Concentrate grades over 30% copper
- 190µm sulphide material and 160 µm for transitional material selected for the PEA base case. Test work indicates that a coarser grind (> 200 µm) may be optimized for sulphide materials in future.
- Assay data and metallurgical test work from variability sample concentrates confirmed no deleterious elements above penalty levels
- Solid-liquid separation test work confirmed processed material is amenable to dry stack tailing storage

Domain	Recovery (%)		
	Cu	Mo	Ag
Oxide	75.0%	n/a	n/a
Transitional	74.7%	70.9%	66.9%
Sulphide	94.4%	74.9%	78.1%

Notes: Summary of tonnes weighted average of metallurgical recoveries by domain and by commodity, as applied in the PEA.; Metallurgical recoveries in the PEA were applied using regression curves as a function of head grade; n/a = not applicable

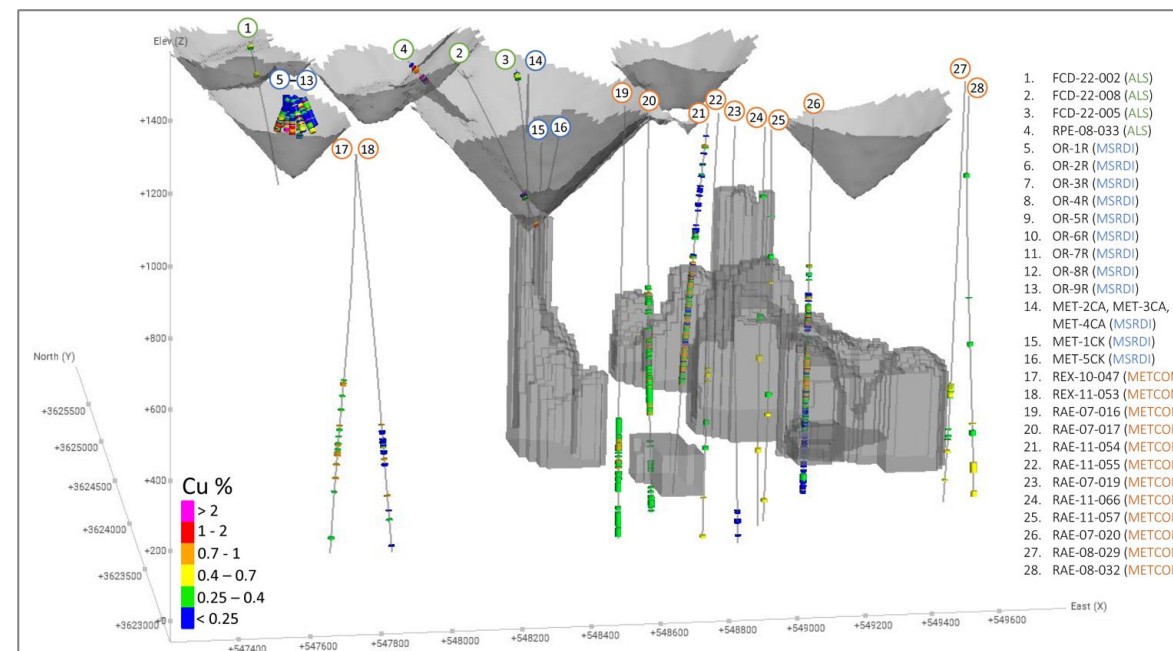

Notes: The image displays metallurgical composite samples overlaid with open pit shells and underground shapes as part of the RPEEE process used to constraint the current MRE

PROCESSING FLOWSHEET

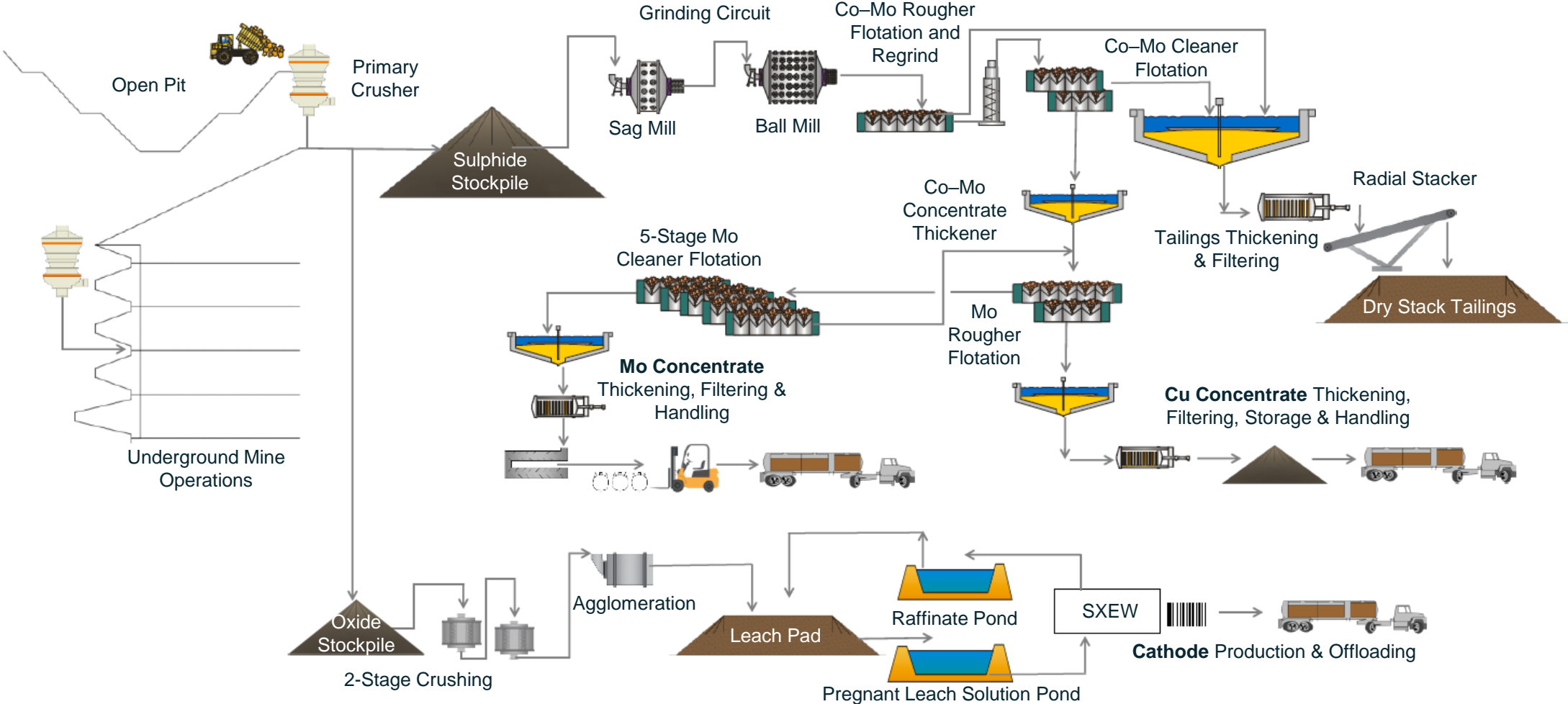

MINE PRODUCTION SCHEDULE



Life-of-Mine Processed Material

Total Processed Material by Material Type

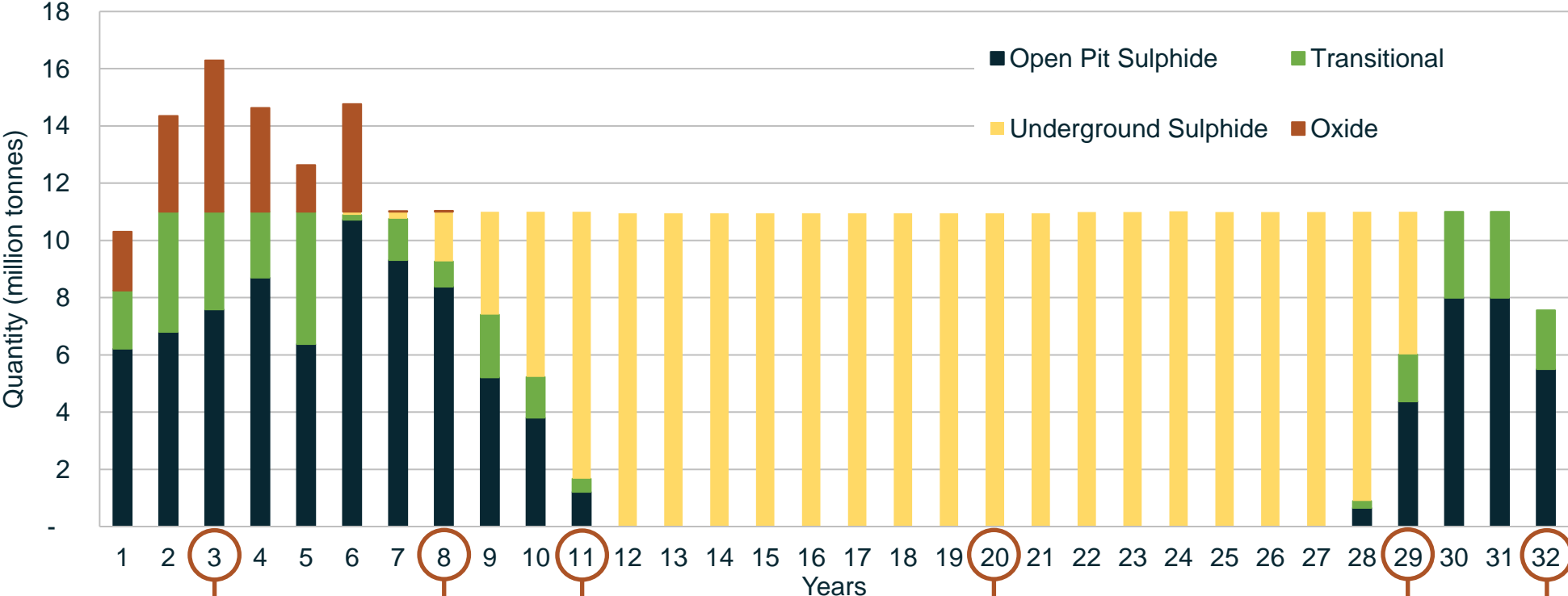

Moly Circuit Commissioned
Underground Development Commences

Open Pit Mining Complete – Stockpile depletion continues

Keel Cave Production Commences

American Eagle Cave Production Commences

Keel Cave Production Complete

American Eagle Production Complete

Open Pit Stockpile depletion complete

OPEN PIT MINE PRODUCTION SCHEDULE

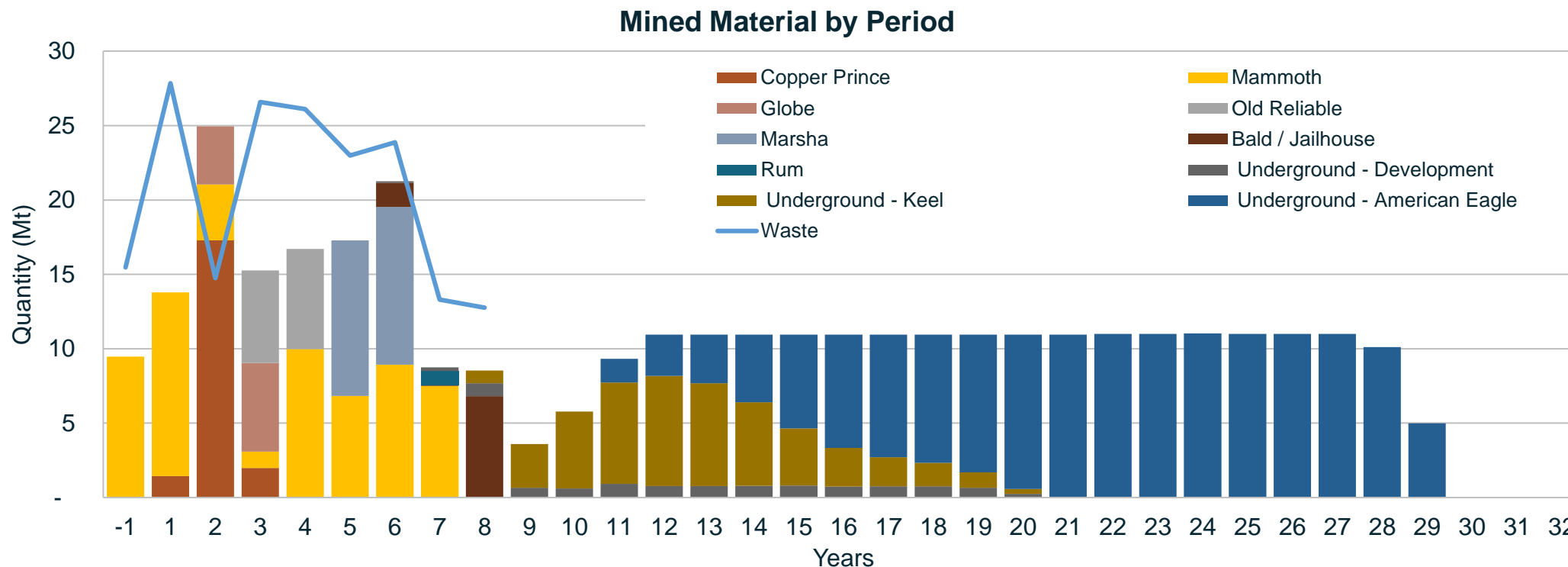

- Open pit is actively mined over 9 years (including pre-strip)
- Higher-grade forward approach supported by stockpile strategy
- Low-grade stockpile:
 - 19.8 Mt is processed as supplementary feed between Years 7-11
 - 36.5 Mt is processed between Years 28 -32

Note: All material reflected in this chart is mineralized mill feed unless denoted as 'Waste'.

UNDERGROUND MINE PRODUCTION SCHEDULE



Underground Development Metres and Mill Feed by Period

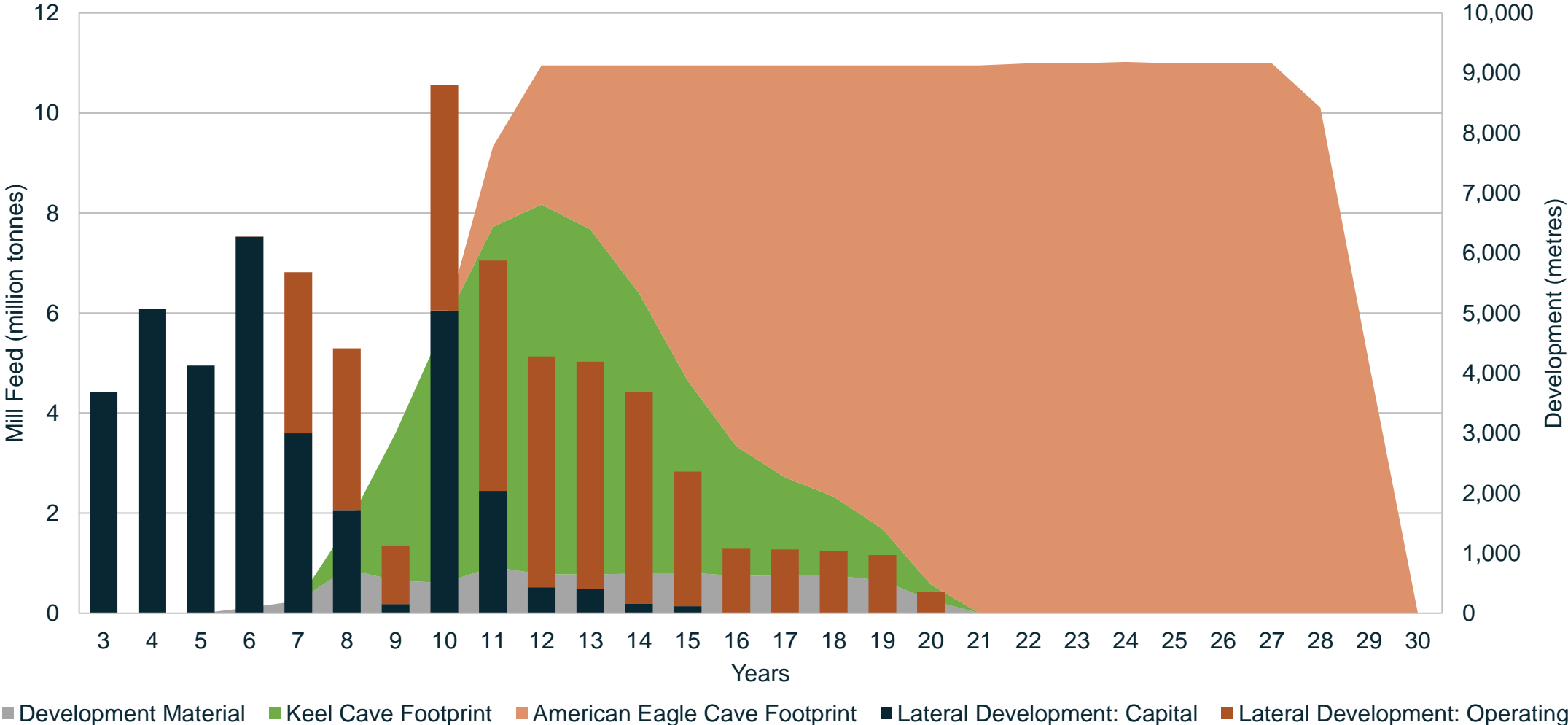

SITE INFRASTRUCTURE



Configured for scalability

Materials handling synergies between open pit and underground

Prioritizes processing and tailings infrastructure on private land

Leverages regional infrastructure such as power, roads and rail

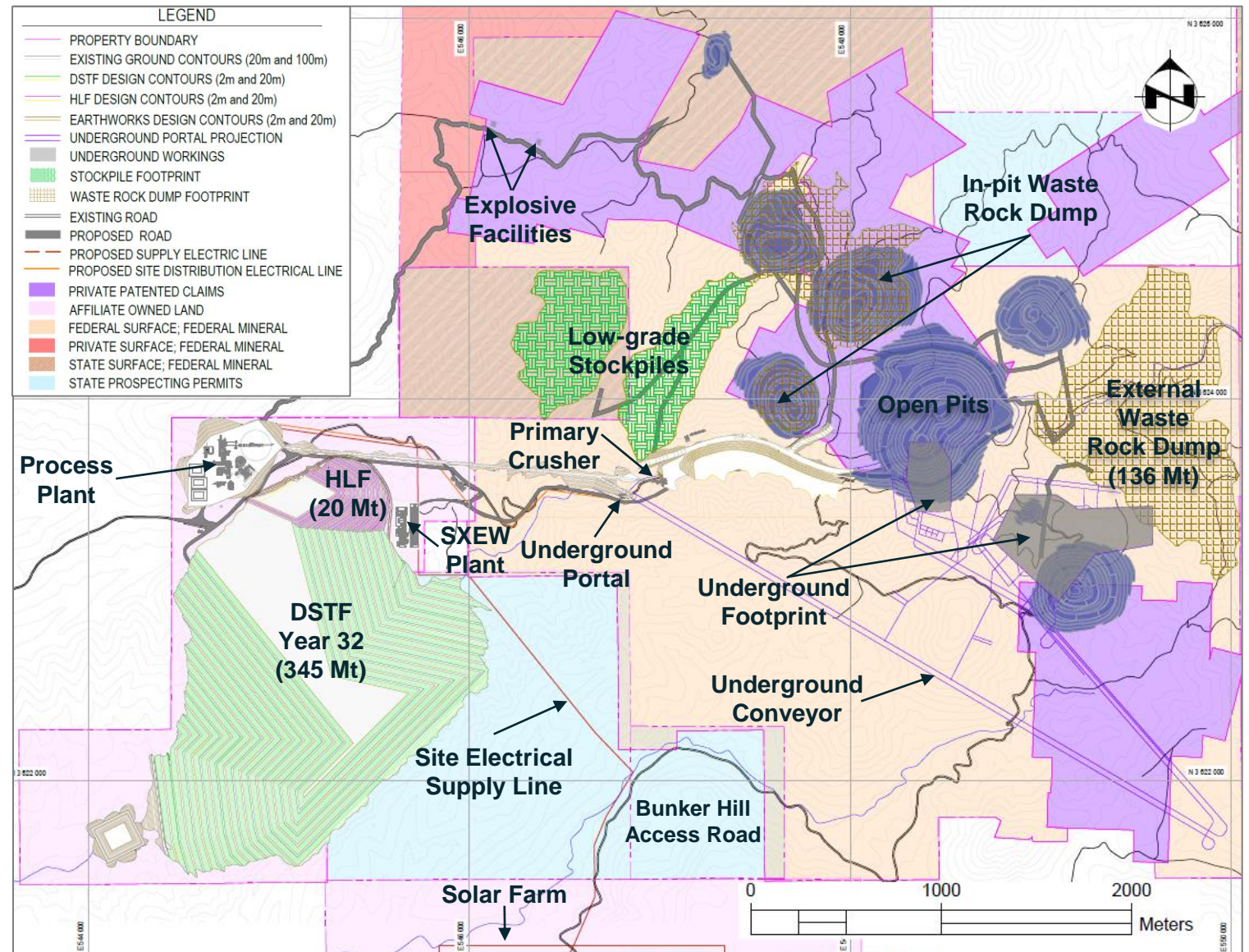

CAPITAL EXPENDITURES



Low Initial Capital with a two-year construction period

Developed using EPCM project development approach with quotes, design driven quantity estimations and first principles

- **Initial Capital includes:**
 - Process plant and oxide infrastructure, crushing and materials handling
 - Mining and site infrastructure includes pre-strip activities and based on contractor operated surface mining
- **Expansion Capital is associated with:**
 - Addition of a molybdenum circuit (Year 3)
 - Underground development and infrastructure
 - Underground equipment required for production
- **Contingency:**
 - The initial capital cost estimation for the processing infrastructure has a 20% contingency application.
 - Total initial capital has a 15% contingency consideration, reflective of the detailed capital estimation basis
- **Closure and Reclamation:** Progressive reclamation approach (including 20% contingency)

Initial Capital Expenditure

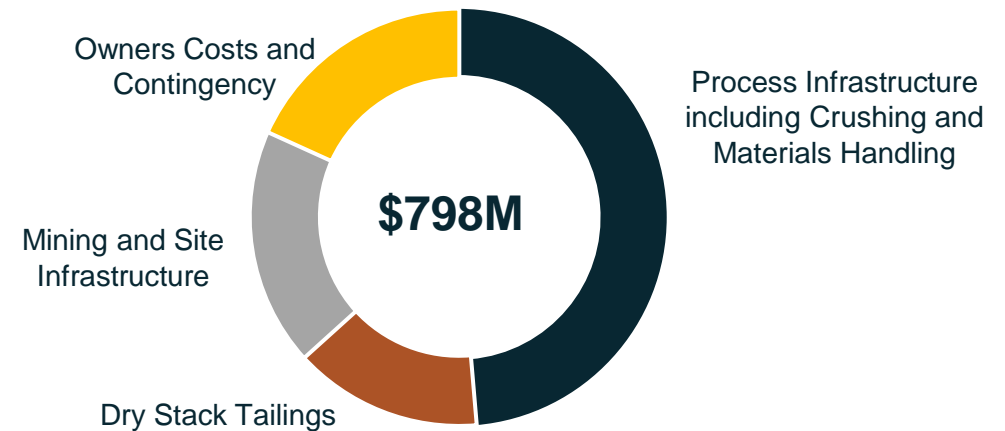

Sustaining / Expansion Capital Expenditure

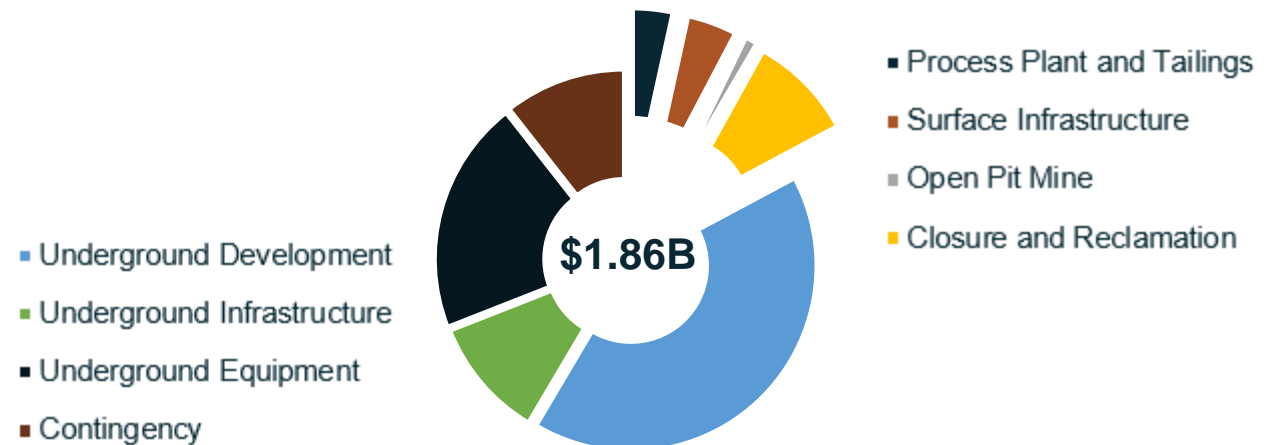

OPERATING COSTS



Average Life-of-Mine Production Cash Costs³ of \$1.67/lb Copper

Open Pit: Contractor-operated conventional truck and shovel

- Open pit operating cost applied to mineralized material and waste
- Mill feed from stockpiles has additional rehandle costs

Underground: Underground pre-production development via contractor, transitioning to owner-operated block caving

- Cost per tonne excludes capitalized development
- Cost inclusive of key activities such as production mucking, crushing, conveying, mine services and mine operating staff

Processing: Discrete estimates for material types and includes mill G&A

- Sulphide at \$5.91/t processed
- Transitional at \$5.74/t processed
- Molybdenum plant adds additional \$0.39/t processed
- Oxide at \$6.71/t leached

Offsite Charges: includes land transportation costs and refining charges for overseas smelters

G&A: Benchmarked against comparable sized operations

- The project would not require a camp facility given accessible from nearby townsites
- Includes Arizona Property taxes

Developed from first principles based on quantities generated from mine design, production schedule and processing by material type

Operating Costs	Units	Open Pit	Underground
Mining ^a	\$/t mined	\$2.43	\$7.30
Processing ^b	\$/t processed	\$6.26	\$6.30
Offsite charges ^c		\$2.51	\$2.51
General and administrative (non-mill) ^d		\$1.45	\$1.45
Total unit costs ^e	\$/t processed	\$13.01	\$17.56

^a Open pit mining unit costs apply to both mineralized material and waste, but exclude stockpile rehandle costs of \$1.47/t rehandled. Underground mining unit costs exclude capitalized development and mill feed generated from mine development.

^b Includes processing-related general & administrative costs.

^c Offsite charges are based on land transportation costs of \$46.35 per wet metric tonne, treatment charges of \$75.00 per dry metric tonne, refining charges of \$0.080/lb, \$0.50/oz, and \$1.30/lb for copper, silver, and molybdenum, respectively.

^d Includes \$0.45/tonne average cost over the life of mine related to Arizona property tax.

^e Amounts will not sum as mining costs are presented on a per tonne mined basis.

ECONOMIC SENSITIVITY

Well-positioned to Leverage the Copper Price

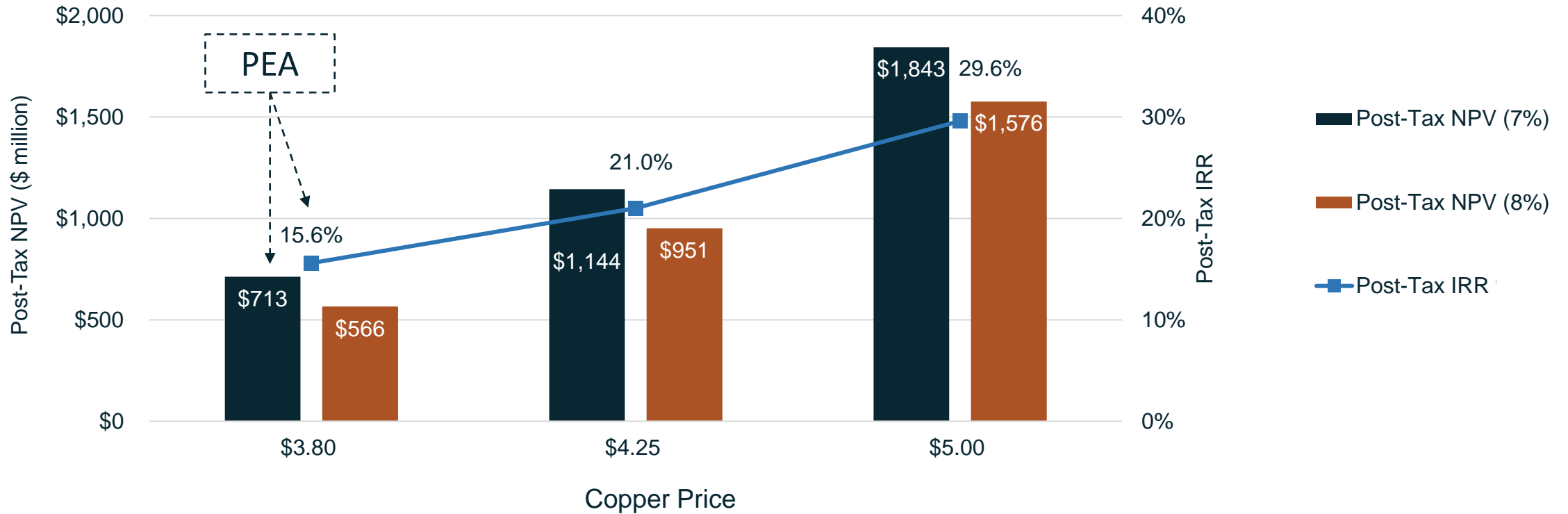

- **Molybdenum:** An increase of \$10/lb would increase the post-tax NPV_(7%) by approximately \$129 million
- **Silver:** An increase of \$5/oz would increase the post-tax NPV_(7%) by approximately \$15 million

TARGETING NEW DISCOVERIES

Empirical Data Informs Technical Decisions



New Airborne Geophysical Survey (VTEM)

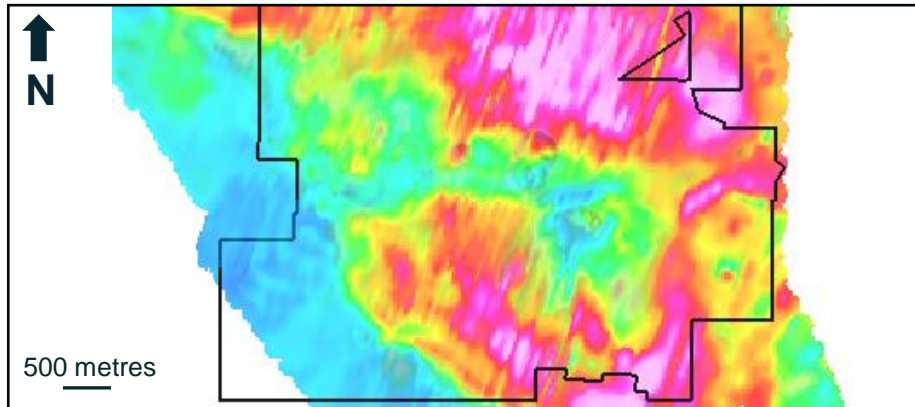

New Airborne Spectral Survey

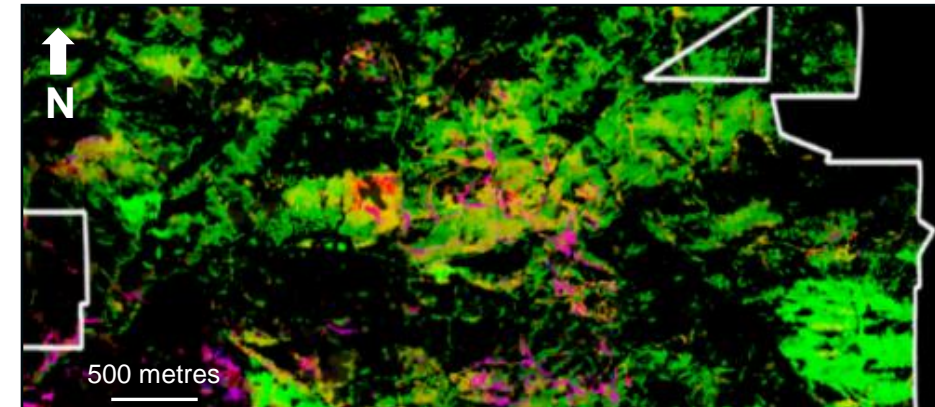

New Structural Interpretation

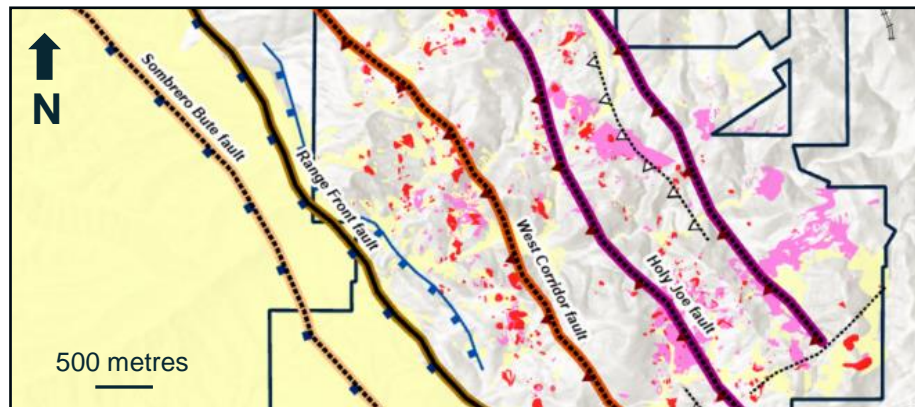

New Geophysical Processing (ZTEM)

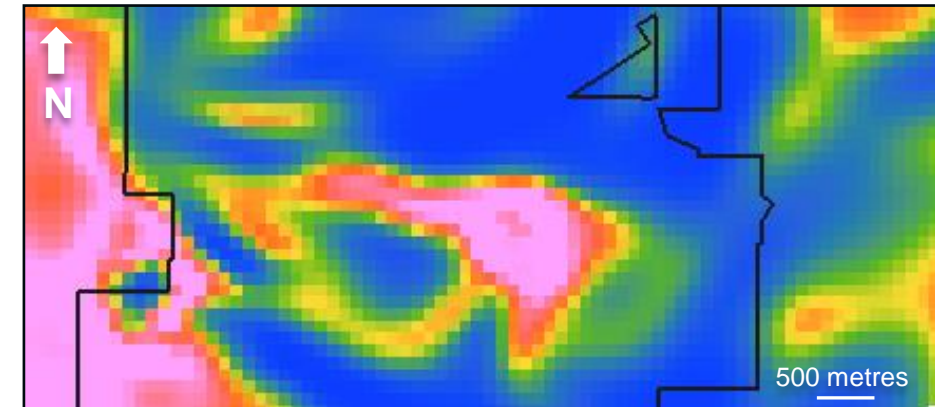

PERMITTING PATHWAY

Plan of Operations and 404 Permit

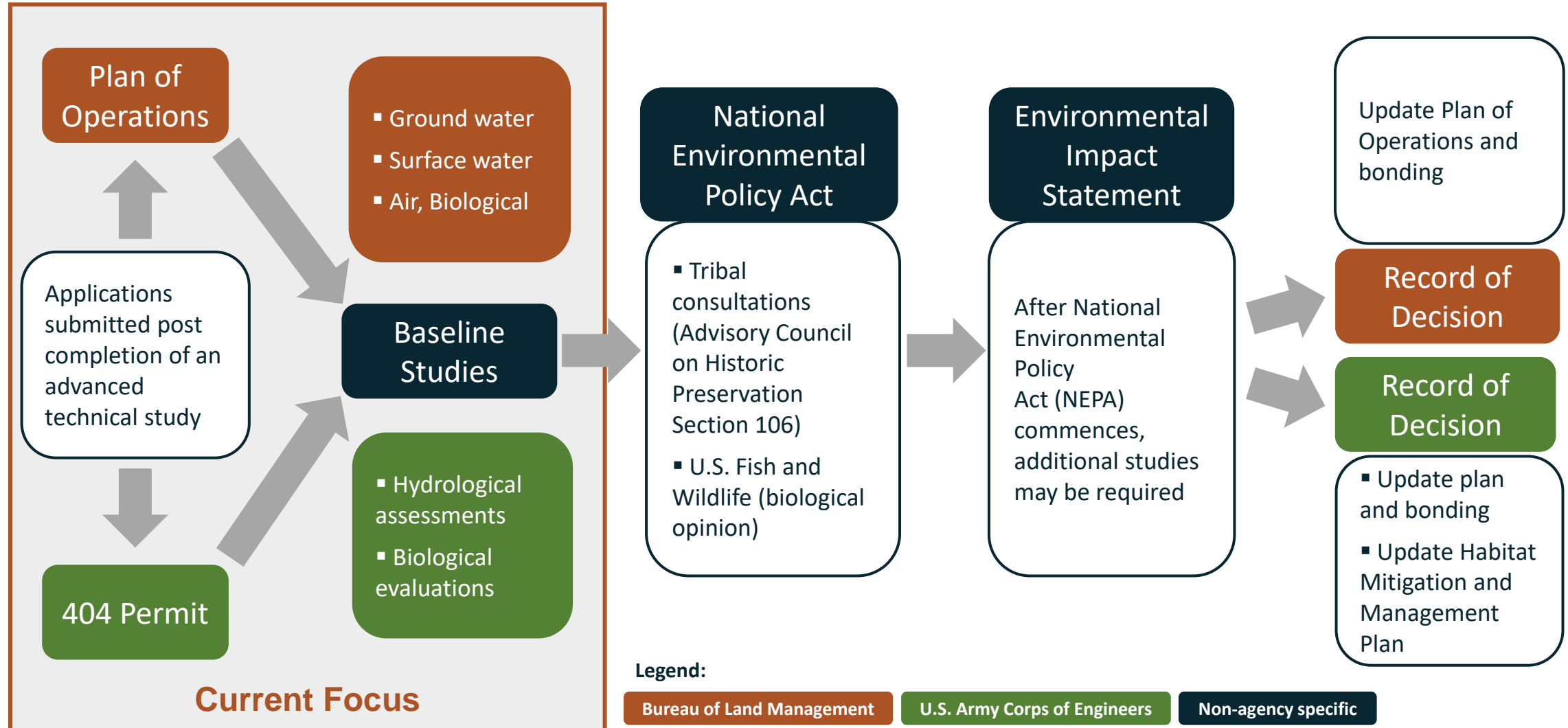

COPPER CREEK ENDNOTES



1. Preliminary Economic Assessment (“PEA”) copper equivalent (“CuEq”) values are calculated using commodity type and price, considering the relevant recovery rate based on domain, applied using a regression formula as a function of grade. Recovery regression formulas are based on the outcomes of the 2023 metallurgical test work and associated recovery guidance. Metal prices used in the calculation include \$3.80/lb copper, \$13.00/lb molybdenum, \$20.00/oz silver.
2. Mineral Resource Estimate (“MRE”) copper equivalent values are calculated using commodity type and price, considering the relevant preliminary recovery rate based on domain. For example, sulphide CuEq = $[(\text{Cu grade}/100 * 0.92 \text{ Cu recovery} * 2,204.62 * \$3.80) + (\text{Mo grade}/100 * 0.78 \text{ Mo recovery} * 2,204.62 * \$13.00) + (\text{Ag grade} * 0.50 \text{ Ag recovery} * \$20.00/31.10348)] / (0.92 \text{ Cu recovery} * 2,204.62 * \$3.80) * 100$.
3. Production cash costs and all-in sustaining cash costs, net of by-product credits, per pound of copper or CuEq are non-IFRS financial performance measures with no standardized definition under IFRS. The Company believes these metrics are useful performance indicators based on industry standards and disclosures. Production cash costs are based on the direct operating costs, including mining, processing, and G&A, offsite charges, net of by-product credits. By-product credits are calculated using commodity prices: \$13.00 per pound of molybdenum, and \$20.00 per ounce of silver. Sustaining cash costs include sustaining capital expenditures and royalties.

Sampling Methodology, Chain of Custody, Quality Control and Quality Assurance:

All sampling was conducted under the supervision of the Company's geologists and the chain of custody from Copper Creek to the independent sample preparation facility, ALS Laboratories in Tucson, AZ, was continuously monitored. The samples were taken as ½ core, over 2 m core length. Samples were crushed, pulverized and sample pulps were analyzed using industry standard analytical methods including a 4-Acid ICP-MS multielement package and an ICP-AES method for high-grade copper samples. Gold was analyzed on a 30 g aliquot by fire assay with an ICP-AES finish. A certified reference sample was inserted every 20th sample. Coarse blanks were inserted every 20th sample. Approximately 5% of the core samples were cut into ¼ core and submitted as field duplicates. On top of internal QA-QC protocol, additional blanks, reference materials and duplicates were inserted by the analytical laboratory according to their procedure. Data verification of the analytical results included a statistical analysis of the standards and blanks that must pass certain parameters for acceptance to ensure accurate and verifiable results.

CONTACT COPPER: EXPLORATION UPSIDE



- 100% owned, 5,900+ acres of patented and unpatented mining claims in Nevada, US
- Excellent access to a major highway, power, water and local mining services
- Open pit, heap-leach copper oxide opportunity
- Deposit open in all directions; additional untested drill targets

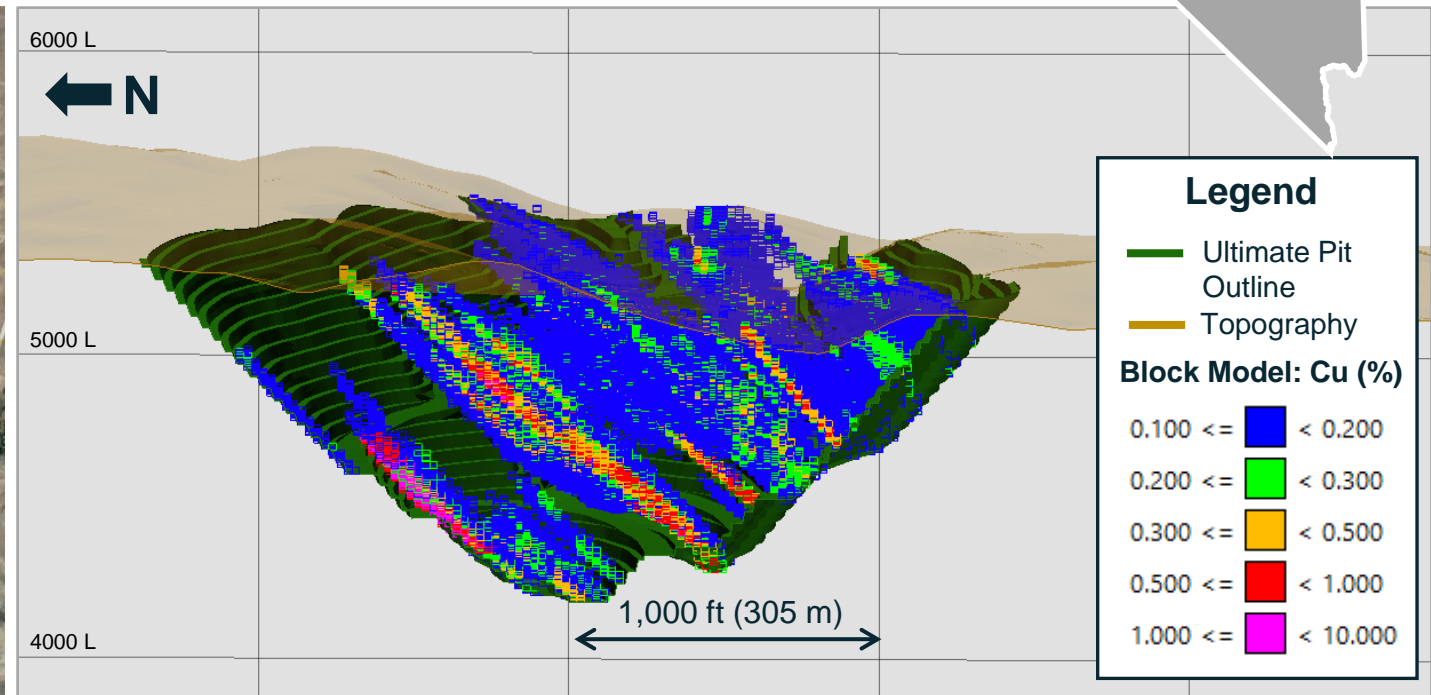
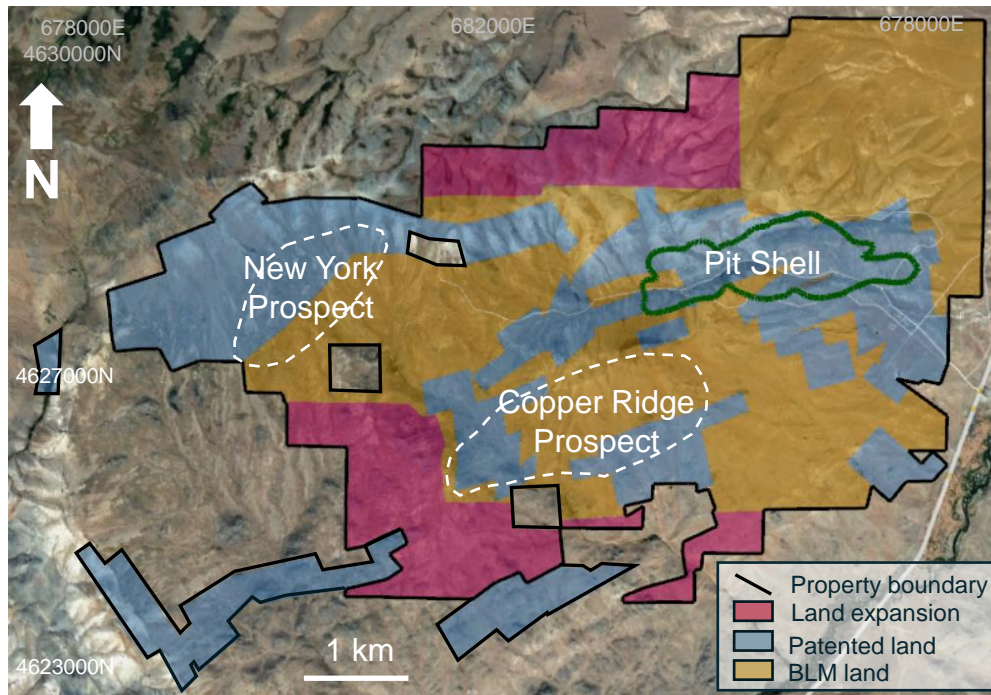
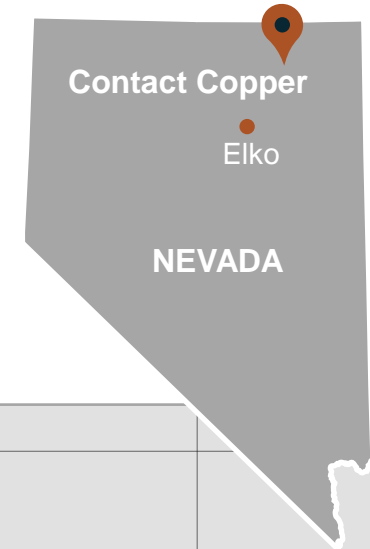

Notes: Conceptual resource block model section from historical data presented in a technical report titled "NI 43-101 Pre-Feasibility Study on the Contact Copper Project" prepared for International Enxco, Ltd. by Hard Rock Consulting, LLC dated and filed by International Enxco Ltd. on SEDAR on October 1, 2013.



FARADAY COPPER

CONTACT INFORMATION

Suite 250, 200 Burrard Street
Vancouver, BC Canada
www.faradaycopper.com

STACEY PAVLOVA, CFA

VP Investor Relations
778-730-1067
info@faradaycopper.com